

The 3M logo is displayed in its characteristic red, bold, sans-serif font.The DBI SALA logo features the text "DBI" in a small font above "SALA" in a larger, bold font, all contained within a blue square border.

Fall Protection

Full Line Catalog

3M™ DBI-SALA® Fall Protection

Bringing safety to every corner of the globe.



Your nationwide 3M distributor:

The logo for Diversified Fall Protection features a blue geometric icon on the left, followed by the word "DIVERSIFIED" in a large, bold, blue font, and "FALL PROTECTION" in a smaller, blue font below it.

(844) 958-1187

fallprotect.com

We do it all for one reason: **YOU.**

Every day, thousands of people around the world go to work and perform tasks at heights most would never dream of climbing to—a dangerous calling that results in thousands of injuries every year.

Whether you're reaching for the sky or crawling into tight confined spaces, our commitment to you remains the same: outfitting you with quality, comfortable 3M Fall Protection, backed by science and designed to help you get the job done and get home safely.

Fall Protection Portfolio.

- Anchors
- Body Harnesses
- Connecting Devices
- Descent and Rescue
- Fall Protection for Tools
- Confined Space
- Engineered Systems

World-class manufacturing & support.

10 Manufacturing Sites
17 Distribution Centers
20 Sales & Customer Service Centers
200+ Approved Repair Centers supporting
all 20,000+ of our products.

Dedicated training & education.

10+ Safety Training Centers & **60**
Fall Protection Demo Vehicles serving people
with valuable knowledge and best practices
anytime, anywhere.



Customer service you can count on.

Your work never slows down—and neither do we. Our Customer Service team is committed to ensuring you have the 3M Fall Protection you need when and where you need it.

Velocity Shipping

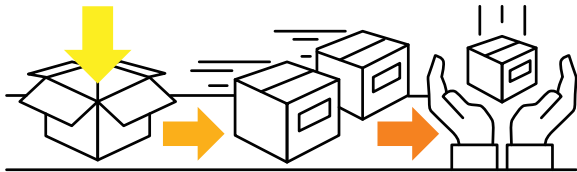

**Velocity Ship
items available
to ship same day**

*on orders
placed
before
12pm CST.*

Flat Fee Product Repair

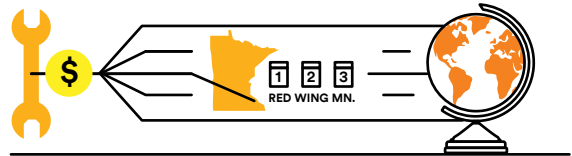

**Many of our products can be repaired
at our Red Wing, Minnesota facility**

in just 3 days

or they can be repaired at one of our

over 200 Approved
Repair Centers.

Training that goes beyond the textbook.

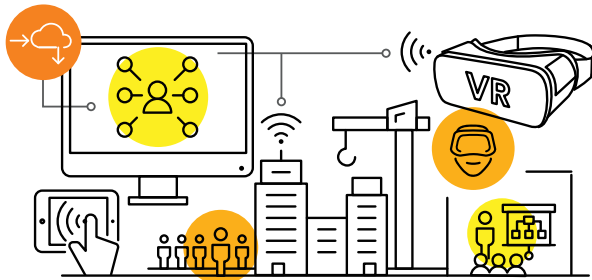

3M's full range of fall protection, confined space and rescue training courses are offered throughout the year at our state-of-the-art training centers. 3M also offers on-site safety training across our portfolio that is tailored to meet the unique environment of your facility.

At our site or yours, you can trust 3M Fall Protection to provide world-class fall safety training. Topic areas include:

- ▶ Fall Protection Training Courses
- ▶ Confined Space Training Courses
- ▶ Rescuer Training Courses
- ▶ Advanced Level Training Courses
- ▶ Fall Protection for Tools Training Courses

[3M.com/SafetyTraining](https://www.3m.com/SafetyTraining)

We help you unravel the regulations.

Walking-Working Surfaces

From rooftops and ladder cages to outdoor advertising and more, we offer a full suite of information and versatile fall protection solutions to help bring your facility up to compliance with OSHA's 29 CFR 1910.30 mandate. For vertical safety solutions, see our Lad-Saf™ Systems and Ladder SRL Anchors (pg. 24) and a variety of other anchorage solutions to help you get compliant (pg. 5).

Leading Edge Applications



As common as they are hazardous, leading edges—or the unprotected side and edge of a floor, roof or formwork for a floor—require specialized fall protection designed for the task. That's why we've developed a distinctive orange icon that we placed all of our leading-edge certified 3M Fall Protection products, such as our self-retracting lifelines (pg. 65) and shock-absorbing lanyards (pg. 87).



The gear you need. The savings you want.

Trade In, Trade Up Program

We're so confident you'll love our fall protection products that we'll let you trade in your current gear and give you a rebate on new purchases. Harnesses, SRLs, lanyards and more — we're including over 1,200 products to choose from.

If you already use 3M Fall Protection products, you can trade up to get rebates when you upgrade on gear with more features and benefits. It's a great time to assess your equipment and make the switch to 3M™ DBI-SALA® Fall Protection.

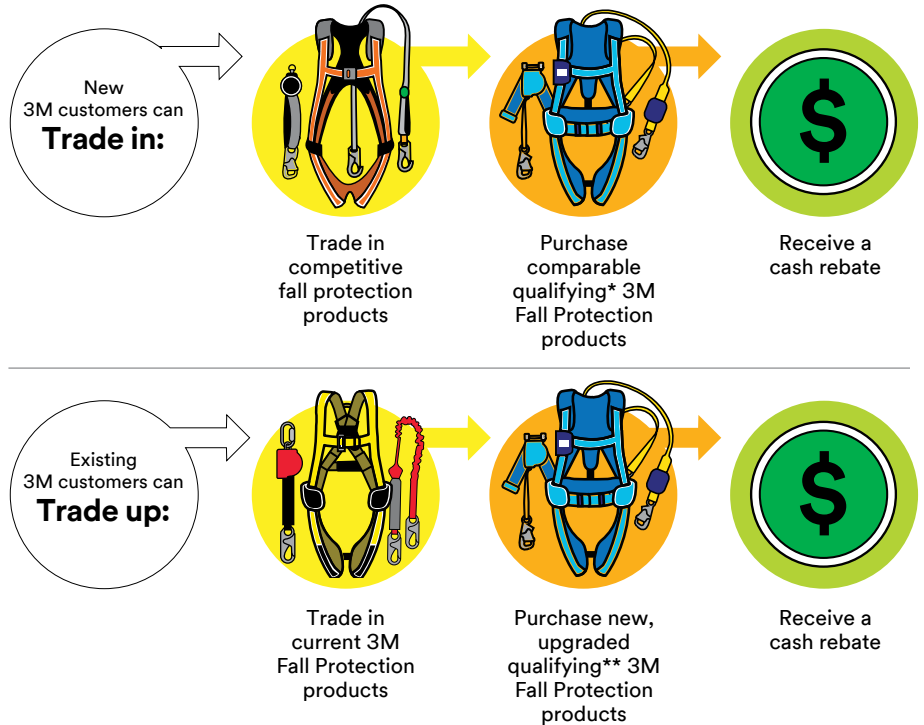

Calculate your rebate at go.3M.com/FPtradein.

Connecting like never before.

3M Connected Safety is a cloud-based, Internet of Things (IoT) platform that combines data science and our PPE technology to help organizations advance the digital transformation of worker safety.

That means workers can be confident they're using products properly, and safety managers can have peace of mind that those products have been properly maintained, inspected and operated day in and day out.

Safety & Inspection Manager (SIM)

Gain valuable access to real-time product information and servicing data with a tap of your phone. Your customized dashboard gives you exactly the information you need and helps you track your PPE inventory like never before.

Now offering a Basic Fall Protection package to help meet your PPE inspection needs.



3M.com/ConnectedSafety

The ABCs of fall protection.

With over 20,000 products designed for the specific needs of every industry with at-height hazards, we can find the just-right combination of anchorages, body support and connector solutions to meet the requirements of virtually any application.

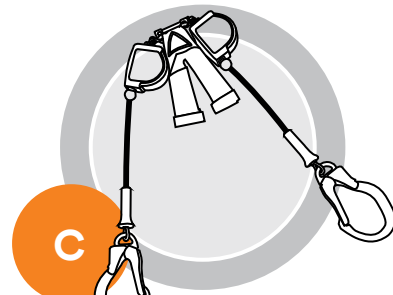
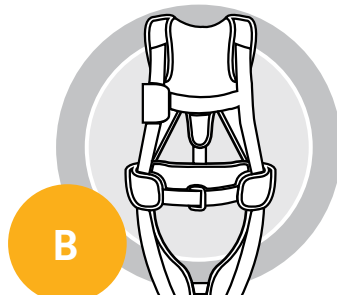
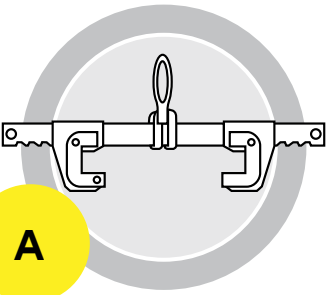

Anchorage

are a secure point of attachment. Anchorage connectors vary by industry, job, type of installation and structure. They must be able to support the intended loads and provide a sufficient factor of safety for fall arrest.

Anchorage connectors 5
Horizontal systems15
Vertical systems 23
Engineered systems31
Flexiguard™ solutions 35

Body support

harnesses distribute fall forces over the upper thighs, pelvis, chest and shoulders. They provide a connection point on the worker for the personal fall arrest system.

Full-body harnesses 45
Lineman belts and harnesses 62
Belts, workseats and accessories 63

Connectors

such as self-retracting lifelines or shock-absorbing lanyards connect a worker's harness to the anchorage.

Leading edge connectors 65
Self-retracting lifelines71
Shock-absorbing lanyards 87
Fall-restricting devices 94

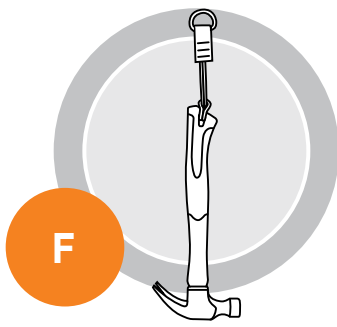
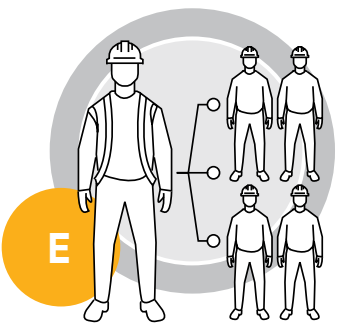
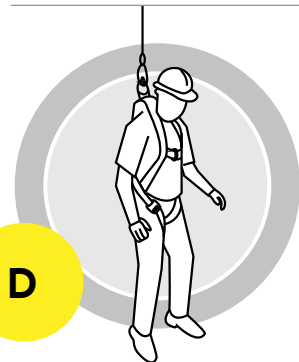

Descent and rescue

devices are used to raise or lower a fallen injured worker to safety or retrieve him from a confined space.

Confined space rescue 95
Rescue and descent112

Education

is essential. We offer a variety of training and consultative services to fit your needs.

Training courses118

Fall protection for tools

helps make work environments safer and more productive by reducing dropped object incidents.

Fall protection for tools 120

Anchors designed to help you stay focused on the job.

Set your sights on a higher level of confidence and security with 3M™ DBI-SALA® Anchorage Connectors. Tested to meet OSHA and ANSI standards, our comprehensive portfolio of anchorage connectors gives you the gear you need to get the job done right.

- Anchorages for general/all-purpose, steel, concrete, roof, mining or specialty.
- Fixed or mobile.
- Permanent or portable.

All anchorages must provide a secure point of attachment for a complete personal fall arrest system and must be capable of supporting a load of 5,000 lbs. (22 kN), or of meeting OSHA's criteria of a 2-to-1 safety factor.



Anchorage Connectors: New Products



2104709

Strut Anchor

See page 7 for more information.



2104710

Sliding Beam Anchor

See page 7 for more information.



2190071

Swiveling Roof Anchor

See page 10 for more information.



2190073

Standing Seam Roof Anchor

See page 10 for more information.



2190074

Construction Roof Anchor

See page 10 for more information.

3M™ DBI-SALA® General Anchorage Connectors

Anchors are easily choked-off to the anchorage structure, to provide a fast and safe 5,000 lb. (22 kN) tie-off point for your personal fall protection system.

1003000

Web Tie-Off Adapter

Pass-through design. 1-3/4 in. polyester strength member with 3 in. wide polyester wear pad x 3 ft. (0.9 m)

1003006 Web Tie-Off Adapter, pass-through type x 6 ft. (1.8 m)

1002103 Adjustable Web Tie-Off Adapter, pass-through type x 3 ft. (0.9 m)

1002106 Adjustable Web Tie-Off Adapter, pass-through type x 6 ft. (1.8 m)

1002010 Web Tie-Off Adapter, pass-through type x 10 ft. (3.0 m)



1201390

Web Scaffold Choker

Choker style attaches to 3 in. (76 mm) diameter anchorage. 1 in. (25 mm) polyester strength member x 17 in. (43 cm)

1201391 Web Scaffold Choker x 24 in. (61 cm)

1201422 Coated Web Scaffold Choker, PVC Coated D-ring x 2 ft. (0.6 m)



1002202

Tie-Off Adapter for Hot Work Use

Reinforced with Kevlar® fiber webbing; ideal for high heat environments, pass-through type with 1-3/4 in. polyester strength member x 6 ft. (1.8 m)

1002200 Tie-Off Adapter, with Kevlar® fiber, pass-through type x 3 ft. (0.9 m)

1002201 Tie-Off Adapter, with Kevlar® fiber, pass-through type x 4 ft. (1.2 m)



3M™ DBI-SALA® Saflok™ Steel Carabiners



2000112

11/16 in. (17.5 mm) gate opening steel carabiner with self closing/locking gate. 3,600 lb. (16 kN) gate strength.

2000113

1-3/16 in. (30 mm) gate opening steel carabiner with self closing/locking gate and captive eye pins. 3,600 lb. (16 kN) gate strength.

2000114

2-3/16 in. (55.5 mm) gate opening steel carabiner with self closing/locking gate and captive eye pins. 3,600 lb. (16 kN) gate strength.

5900550

Cable Tie-Off Adapter

Pass-through design. 7 x 19 (9.5 mm) stainless steel cable with O-rings x 4 ft. (1.2 m)

5900551 Cable Tie-Off Adapter, pass-through type x 6 ft. (1.8 m)

5900552 Cable Tie-Off Adapter, pass-through type x 10 ft. (3.0 m)



2104816

Drop-Through Anchor

10 ft. (3 m) drop-through anchor with swiveling D-ring for concrete (≥ 4 in. (101.6 mm) thick) and steel, fits 1-1/2 in. to 1-3/4 in. dia. hole (38.1 to 44.5 mm).

2104819 Drop-Through Anchor x 2 ft. (0.6 m)

2104818 Drop-Through Anchor x 6 ft. (1.8 m)

2104817 Drop-Through Anchor x 8.5 ft. (2.6 m)



3M™ DBI-SALA® Steel Anchorage Connectors

Anchors for steel that are lightweight and compact, providing an easy to install and safe 5,000 lb. (22 kN) tie-off point for your personal fall protection system.

2104710

Sliding Beam Anchor

- 3-1/2 in. to 14 in. beam width.
- Size ranges to fit a variety of beams.
- Replaceable wear pads.
- 360-degree swiveling D-ring anchor point.
- Integrated dual ratcheting system.
- Steel and aluminum construction weighs 3.5 lbs. (1.6 kg).
- 5,000 lb. (22 kN) strength

2104715 Sliding Beam Anchor, fits 12 in.–30 in. beam width

Call Customer Service for pallet offerings

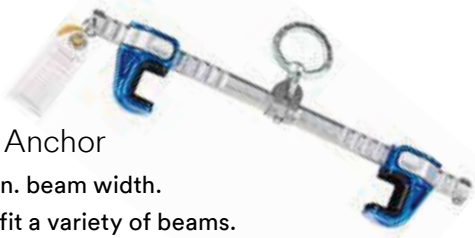

2104709

Strut Anchor

- Allows for one step, one hand installation.
- One-piece design is simple, lightweight and compact.
- Accommodates 1-5/8 in. (4.1 cm) wide strut.
- Includes visual indicator that anchorage is installed correctly and ready for use. (Reflective tape visible from ground level with artificial light source.)



2108406

Fixed Beam Anchor

It installs to the beam structure in any orientation, with final tightening using a built-in adjustment handle. Ideal as a single-person anchor point or as end-anchors for any 3M Pre-engineered Horizontal Lifeline System. Fits up to 1-1/2 in. thick beam flange, 2-1/2 in. to 12 in. wide.

2108407 Fixed Beam Anchor, fits up to 1-1/2 in. thick x 2-1/2 in. to 18 in. wide beam flange.

2108408 Fixed Beam Anchor, fits up to 1-1/2 in. thick x 2-1/2 in. to 24 in. wide beam flange.

2108410 Fixed Beam Anchor, fits up to 1/2 in. to 2-1/2 in. thick x 12 in. to 36 in. wide beam flange.



2103143

Trolley for I-Beam

The trolley is for use with self-retracting lifelines on horizontal beams and has been engineered to glide along the beam and provide horizontal mobility.

- Double-shielded wheel bearings.
- Trolley guards protect the wheels from damage and keep beam clear of debris.
- Fits 3 in. to 8 in. flange width and thickness up to 11/16 in.

2103147 Trolley for I-Beam, all stainless steel, fits 3 in. to 8 in. flange width and thickness up to 11/16 in.



8800023

Tandem Pulley

For 3/8 in. to 1/2 in. rope or cable.

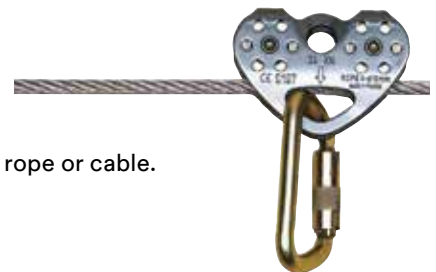

2104550

Steel Plate Anchor

This plate anchor offers a compact attachment to 3/8 in. to 1 in. thick plate steel for connecting your lanyard, vertical lifeline system or self-retracting lifeline.

- Easy-to-use set-screw design ensures positive and safe connection.
- Complete with integral D-ring tie-off point.
- Durable, corrosion-resistant zinc-plated steel construction.



3M™ DBI-SALA® Steel Anchorage Connectors (cont.)

2101630

D-Ring Anchorage Plate

The D-Ring Anchorage Plate can be bolted or welded to a structure, offering a compact connection point for your fall protection system.

- Two 1/2 in. diameter attachment holes.
- Cadmium-plated steel D-ring.
- 304 stainless steel anchorage plate.
- Plate size: 1/4 in. x 2 in. x 4-1/2 in.

2101634 D-Ring Anchorage Plate with cadmium-plated steel D-ring, raw steel anchorage plate.

2101636 D-Ring Anchorage Plate with 304 stainless steel D-ring and anchorage plate.

2101638 D-Ring Anchorage Plate with 316 stainless steel D-ring and anchorage plate.



3M™ DBI-SALA® Concrete Anchorage Connectors

Anchors for concrete that are compact, providing an easy to install 5,000 lb. (22 kN) tie-off point for your personal fall protection system.

2104560

Concrete D-Ring Anchor

Concrete anchor solution for use in temporary or permanent applications, providing a safe tie-off point.

- Reusable D-ring assembly.
- Indicator shows when anchor is properly tightened.
- Install into 11/16 in. (18 mm) or 3/4 in. (19 mm) holes.



2104561 Concrete D-Ring Anchor with 5 additional bolts.

2104562 Concrete D-Ring Anchor with 11 additional bolts.

2100066 10-pack of Replacement Bolts for Concrete D-Ring Anchor.

2101004

Concrete Detent Anchor

Concrete anchor utilizing pre-installed sockets, enabling the user to connect and disconnect from the anchorage by simply pressing a button.

- Use for floor, wall or ceiling type applications.
- Provides convenient tie-off points wherever needed.
- Push-button operation for fast and easy operation.
- Socket includes cover cap to hide recess, blending into the decor.



2101000 Concrete Detent Socket and cap only.

2101002 Concrete Detent Pin only.

2100152 Concrete Pour-in-Place Anchor.

2100169 Pour-in-Place Detent Anchor Assembly with detent pin and socket.

3M™ DBI-SALA® Concrete Anchorage Connectors (cont.)

8523178

Concrete Parapet Anchor

Portable anchorage connector developed for use in locations where a low parapet wall provides an anchor site for a shock-absorbing lanyard or self-retracting lifeline.

- Non-penetrating design.
- Adjustment range 1 in. to 14-1/2 in. wide.
- No tools required for installation.

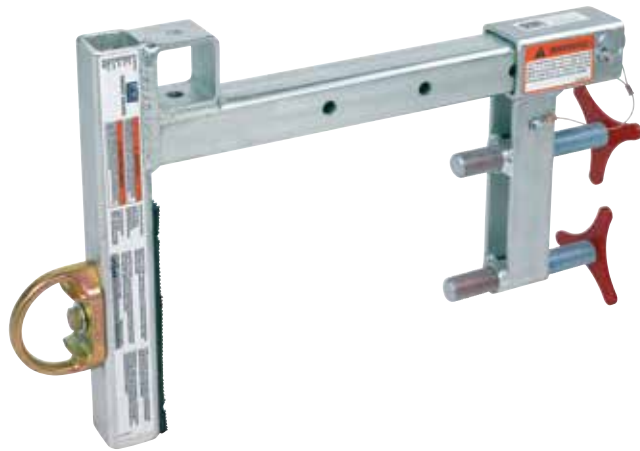

1231305

Web Anchor

Anchor can be directly connected to many concrete wall forms to provide a tie-off point for your system. Web anchor strap with large opening, Hook at one end, D-ring at other x 1.5 ft. (45 cm).



2100050

Concrete Anchor Strap

Our disposable concrete anchor strap provides a temporary anchorage on concrete forms.

- Loop slips over rebar, then concrete is poured over. When no longer needed, simply cut strap and discard.
- Durable 1-3/4 in. polyester construction x 3-1/2 ft. (1 m). Full length wear pad for abrasion resistance.
- D-ring provides compatible tie-off point.



2100053 Concrete Anchor Strap with D-ring, 48 in. (1.2 m)

2100061 Concrete Anchor Strap, no D-ring, 3-1/2 ft. (1 m)

3M™ DBI-SALA® Roof Anchorage Connectors



Wood or steel. Residential or commercial. Flat or sloped. No matter what type of roof you're working on, your fall protection system needs specialized components to help keep you safe. Our anchorage devices help to provide reliable solutions and meet applicable OSHA and ANSI standards for anchorage connectors.



Rooftop Anchors

- Four similar rooftop anchors designed specifically for certain roof types.
- Tip-over design reduces need for structural reinforcement and allows for connection right to roof deck.
- Can be used as a single point anchor, or pair two together to create a temporary horizontal lifeline.

Connection method*

2100138	Rooftop Anchor for Standing Seam Roofs	Standing Seam Clamps	
2100139	Rooftop Anchor for Standard Membrane Roofs	Toggle / Screw	
2100140	Rooftop Anchor for PVC Membrane Roofs	Toggle / Screw	
2100142	Rooftop Anchor for Bitumen Membrane Roofs	Toggle / Screw	

*Call Customer Service for item numbers.



2100185
Freestanding Counterweight Anchor



2103670
Permanent Roof Anchor with Flashing and Cap



2103673
Portable Reusable Roof Anchor



2103677
Portable Reusable Roof Anchor



2104541
Detachable Roof Anchor with Flashing



2103690
3-Man Reusable Swiveling Roof Anchor



2190071
Swiveling Roof Anchor

- Installs to sloped or flat wood and metal decking roofs.
- Fast and easy installation.
- Secondary d-ring anchor point.
- Portable and reusable.



2190073
Standing Seam Roof Anchor

- Installs to flat or sloped standing seam roofs.
- Built-in non-penetrating clamp design.
- Slide on the tube.
- Portable and reusable.



2190074
Construction Roof Anchor

- Installs to rebar ring during pre-cast concrete work.
- Built-in ratcheting securement system.
- Dual-use design.
- Portable and reusable.

Selection Guide:

Part #	Wood attachment - OK	Metal attachment - OK, minimum thickness	OK to Use with HLL	Attachment method	Permanent installation	OSHA compliant
2100133	■ (5/8 in. plywood)	■ 24 Ga.	■	Lag screws (wood), anchors (concrete), rivets or Fablok or Tek screws (metal)	■ (5/8 in. plywood)	■
2100138		■ Fits standing seam centers 15.75 in. x 11.8 in. w/clamp kits	■	7241204 for bulb type seam, 7241206 for double folded standing seam, 7241208 for single folding seam	■	■
2100139		■ Installs to standard membrane and built-up type roofs	■	4 bolts: 7241182 6 in. toggle bolt, or 7241183 12 in. toggle bolt	■	■
2100140		■ Single-ply PVC membrane and built-up roofs	■	4 bolts: 7241182 6 in. toggle bolt, or 7241183 12 in. toggle bolt	■	■
2100142		■ Single ply Bitumin and built-up roofs	■	4 bolts: 7241182 6 in. toggle bolt, or 7241183 12 in. toggle bolt	■	■
2100185		■ Flat roofs up to 5 degrees of slope		4 bolts: 7241182 6 in. toggle bolt, or 7241183 12 in. toggle bolt		■
2103670	■			U-Bolt clamps (included) to rafter or truss, 2 x 4, 2 x 8	■	■
2103671	■			U-Bolt clamps (included) to rafter or truss, 2 x 10, 2 x 12	■	■
2103673	■		■ Synthetic Sayflite™ or PRO-Line of slope	6 (1/4 inch size) Lag screws (included) or 12 nails (included)		■
2190073		■ Flat or sloped roofs		Clamps to seam		■
2190074				Built-in ratchet system that installs to rebar ring		■
2103676	■	■ 22 Ga. deck		Nails or Tek screws		■
2103677	■			Lag screws		■
2103690	■			Deck screws		■
2104540	■			Bolts w/clamp	■	■
2104541	■			Bolts w/clamp	■	■
2104542	■			Bolts w/clamp	■	■
2105682	■			Lag screws or nails		■

Read user instruction manual for complete information on use and limitations.



2104168

Roofer's Fall Protection Kit

Complete fall protection system in a bag for convenient compliance and safety on the job.

Kit includes:

- Reusable Roof Anchor (2103673)
- Full-Body Harness (1103513)
- Rope Adjuster with Shock-Absorbing Lanyard (1246037)
- Lifeline x 50 ft. (1202794)
- Counterweight (5901583)
- Carrying Bag (9503806)

2104169 Roofer's Fall Protection Kit with Roof Anchor (2103676)

3M™ DBI-SALA® Remote Anchoring Systems



2104527

Remote Anchoring System

Provides anchorage connection to secure a fall protection device to an overhead location beyond normal reach.

- Pole adjusts from 6 ft. to 12 ft. (1.8 m to 3.6 m)
- Tie-off adapter tool for installation of anchorage device.
- Hook attachment tool for installation of 3,600 lb. gated snap hooks.
- Tie-off adapter x 3 ft. (0.9 m) and carrying bag.

2104528 System with 8 ft.–16 ft. (2.4 m–4.8 m) adjustable pole

2104529 Snap Hook Connector Tool for 3,600 lb. gated hooks.



2100090

Perimeter Limiter Leading Edge Anchor

Freestanding, non-penetrating anchor for concrete decking construction and provides overhead anchorages for up to two users.

- Large foam filled trailer tires won't go flat and provide easy movement.
- 7-1/2 ft. (2.3 m) mast and anchorage arm for added freedom of movement.
- Pre-drilled holes for accessory rescue winches.



2100080

Door/Window Jamb Anchor

Non-penetrating anchor is lightweight and portable, requiring no tools for attachment. Adjustable opening ranging from 21-1/2 in. to 51-1/2 in. (54.6 cm to 130.8 cm). Rated for 3,600 lbs. (16 kN)

3M™ DBI-SALA® Self-Contained Vacuum Anchor System

This Self-Contained Vacuum Anchor (SCVA) System allows workers to anchor to compatible, smooth, non-porous surfaces—enabling them to work where they need to without compromising their fall protection safety. At just over 19 lbs., the system provides workers the freedom to move about with confidence. All models are OSHA, CE and AS/NZS compliant and feature a comprehensive backup system to enhance worker safety.



3M™ DBI-SALA® Ultra-Lok™ Self Retracting Lifeline, Rope

Page 83



Product specifications:

	Shop air powered	Shop air/gas powered
Main support assembly	Anodized aluminum	
Vacuum seal pad material — aviation	EPDM	
Vacuum seal pad material — general industry	Polybutadiene	
Shop air requirements	80 psi to 150 psi	
Compressed gas bottle requirements	—	3,000 psi, 48 in ³
Dimensions	22 in. x 22 in. x 6 in. (55 cm x 55 cm x 15 cm)	
System weight	17.4 lbs. (7.8 kg)	19.9 lbs. (9.0 kg)
Capacity	310 lbs. (140 kg); One person	
Surface temperature range	-20°F to 140°F (-29°C to 60°C)	

Selection Guide:

Components	Aviation	General industry
SCVA assembly (shop air powered)	2200107	2200094
SCVA assembly with on board bottle attachment (shop air or gas powered)	2200108*	2200095
Secondary pad assembly (optional)	2200109	2200096
Secondary pad hose (optional) — 50 ft. (15 m)	2200130	
Aviation HLL kit (includes secondary pad, 40 ft. HLL, and secondary pad 50 ft. hose)	2200123	—
Compressed gas cylinder (bottle sold separately)	2200085	



3M™ DBI-SALA® Horizontal Systems

Choosing a horizontal lifeline system

It's critical to choose a system that has been precision engineered and rigorously tested to meet OSHA requirements. Some other important considerations include:

Anchorage structure

The I-beam, rebar stud, concrete column or roof you attach your system to can dictate the type of system required.

Portable or permanent

Temporary jobs require portable systems that can be moved efficiently from one location to another. For hazardous areas that need to be accessed often, a permanent solution may be a better choice.

Lifeline type

Synthetic lines are lightweight and compact, while galvanized or stainless steel offer enhanced corrosion and abrasion resistance.

Number of users

Consider the number of workers required and choose a system that can accommodate them safely.

Clearance requirements

The distance between the work area and the next level or obstruction below is called "fall clearance." Anchorage height, type of lifeline and length are some of the factors that will affect the required clearance needed.



3M™ DBI-SALA® Temporary Cable Horizontal Lifeline System for Stanchions

These systems incorporate a modular, multi-base design that accommodates a wide range of steel and concrete beams.

- Interchangeable stanchions—great for steel and concrete applications.
- Portable.
- Single and multi-span options available.
- Pass-through bracket provides 100% tie-off capability.
- Integrated 3M™ DBI-SALA® metal energy absorber limits forces on structure.

Steel I-Beam Applications

- Single clamp and wing nut design.
- Adjustments made from top of beam.
- Fits flanges 6 in.–12 in. wide, 2-1/4 in. thick.
- Optional bases for 18 in., 24 in. and 36 in. widths.

Concrete rebar & shear stud applications

- Attach with torque wrench.
- Chain tie-back connection.
- Fits 1/2 in–1 in. diameter (#4–#8 rebar) and 4 in.–12 in. center to center.

3M™ DBI-SALA® Temporary Cable Horizontal Lifeline System for Stanchions

Complete single span system includes two stanchions (7400047) and cable assembly with tensioner and metal energy absorber. 60 ft. (18.3 m)



Shown with tie-back base with chain.

Selection guide:

	Stanchion	Tie-Back Base
I-Beam	7400047	-
Rebar/Shear Stud	7400215	7400214

Systems shown with intermediate stanchions—sold separately.

3M™ DBI-SALA® Temporary Cable Loop Rebar Horizontal Lifeline System for Stanchions

These complete single-span systems include two stanchions and cable assembly with tensioner and metal energy absorber.

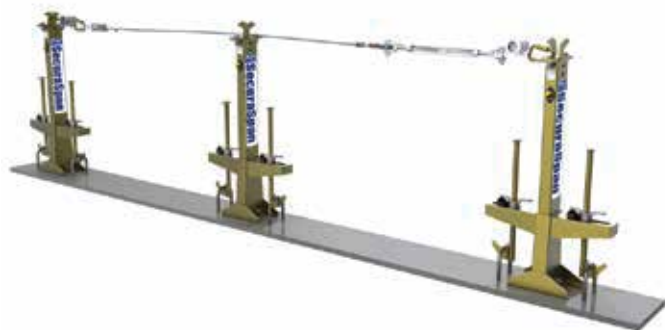

Selection guide:

20 ft.	40 ft.	60 ft.	Stanchion
7400320	7400340	7400360	7400045

Systems shown with intermediate stanchions—sold separately.

7400045

Stanchion with Loop Rebar Base and Pass-Through Bracket



3M™ DBI-SALA® Temporary Cable Horizontal Lifeline System for Stanchions I-Beam Components

7400087

Perpendicular I-Beam System Components Stanchion with Perpendicular I-Beam Base
No tie back, fits 8 in.–14 in. flange.

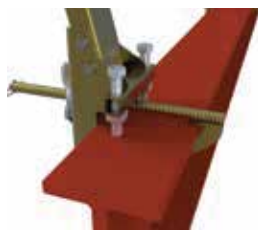

7400086

Perpendicular I-Beam Base Only
Fits 8 in.–14 in. flange.



7400089

Perpendicular Pass-Through Kit

3M™ DBI-SALA® Temporary Cable Horizontal Lifeline System for Stanchions Parallel I-Beam Components

	6 - 12 in. Flange	12 - 18 in. Flange	18 - 24 in. Flange	24 - 36 in. Flange
Stanchion with I-Beam Base	7400047	7400055	7400056	7400057
I-Beam Base Only	7400052	7400065	7400066	6700067
Stanchion with I-Beam Base, Range of 2-2/3 in. to 3-3/8 in. Thick Flange	7400015	7400032	7400033	7400034

3M™ DBI-SALA® Temporary Cable Horizontal Lifeline System for Stanchions Cable Assembly

Available 10–330 ft. lengths in 10 ft. increments. Cables available up to 720 ft.—please call customer service for part number on any cable over 330 ft. in length.

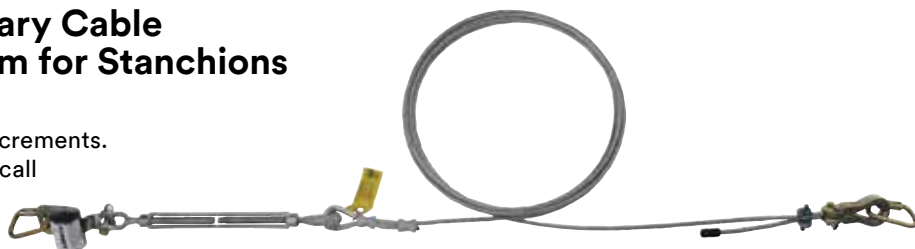

Lifeline options for all systems—cable assembly with turnbuckle and metal energy absorber are available in 10 ft. increments. Cable assemblies over 60 ft. include two metal energy absorbers.

3M™ DBI-SALA® Temporary Cable Horizontal Lifeline System for Stanchions Rebar System Components

7400215

Stanchion with Rebar/Shear Stud Base
Pass-through and end anchor brackets.

7400053

End-Anchor Retro-Fit Kit
With rebar/shear stud base, tie-back assembly, end-anchor and pass-through bracket.

7400054

Intermediate Retro-Fit Kit
With rebar/shear stud base and pass-through bracket.

7400214

Tie-Back Base and Chain Assembly



3M™ DBI-SALA® EZ-Line™ Retractable Horizontal Lifeline (HLL) System



7605060

Retractable Horizontal Lifeline (HLL) System

This is an easy-to-use lifeline system that you can install, remove and store quickly.

- Can reduce installation time vs. standard horizontal lifeline systems.
- Can be setup to accommodate 6 total users (2 per sub-span).
- Includes built in pre-tension and impact indicators.

7600002 Replacement EZ-Line Handle Assembly

See product instruction manual for complete clearance information.

7241031 Metal energy absorber kit used when multi-spans are required

3M™ DBI-SALA® Temporary Cable Horizontal Lifeline System

These systems are portable and can be used for situations where welding, sparks or harsh environments are present, or where minimum clearance exists.

- Includes cable lifeline assembly with wedge grip termination, tensioner and 3M™ DBI-SALA® metal energy absorber.
- Durable all-metal system can be left in place for long periods.
- Use with any 5,000 lb. anchorage device.
- Two worker capacity.



Adjusts cable with Wedge Grip termination.

Selection guide

Most popular length

20 ft.	30 ft.	40 ft.	50 ft.	60 ft.	70 ft.	80 ft.	90 ft.	100 ft.
7602020	7602030	7602040	7602050	7602060	7602070	7602080	7602090	7602100

See product instruction manual for complete clearance information.

3M™ DBI-SALA® Temporary Kernmantle Rope Horizontal Lifeline System

Portable systems that can be used for maintenance, bridge work, construction and general industry applications.

- Kernmantle rope lifeline with tensioner and shock absorber.
- Capacity of two workers.



Selection guide:

Most popular length

20 ft.	30 ft.	40 ft.	50 ft.	60 ft.	70 ft.	80 ft.	90 ft.	100 ft.
7600502	7600503	7600504	7600505	7600506	7600507	7600508	7600509	7600510

See product instruction manual for complete clearance information.

3M™ DBI-SALA® Temporary Cable Pour-in-Place Horizontal Lifeline System for Stanchions

7400203

This portable system installs to column tops, providing an overhead tie-off point during the decking process. Complete system includes two stanchions, and 20 ft. cable assembly with tensioner and 3M™ DBI-SALA® metal energy absorber.

- Single and multi-span options with unlimited length.
- Pass-through design provides protection for up to two workers.



3M™ DBI-SALA® Temporary Cable Pour-in-Place Horizontal Lifeline System for Stanchions Accessories

7400200

Intermediate Bracket

Allows system to be configured into multi-span type; intermediate can be bypassed with connector snap hook.



7400203

Stanchion Assembly

7 ft. 6 in. tall.



7400201

Concrete Sleeve

For pour-in-place post horizontal lifeline systems.



7400211

Clamp-On Vertical Base

Clamps to existing vertical steel and concrete structures, zinc-plated steel construction.



7400218

Bolt-On Vertical Base

Bolts to vertical steel and concrete structures, zinc-plated steel construction.



7400222

Weld-On Vertical Base

Welds to vertical steel structures, steel C-channel construction.



8530267

Bolt-On Floor Base

Bolts to steel and concrete horizontal surfaces, zinc-plated steel construction.



8530827

304 Stainless Steel.

3M™ DBI-SALA® Horizontal Lifeline Components

3M™ DBI-SALA® Metal Energy Absorber Kits

Allows use of standard 5,000 lb. rated anchors.

Accessory products:

1. Cable clips — 9501563
2. O-rings — 9503880
3. Thimbles — 9506596
4. Turnbuckle — 7002050
5. Wedge Grip Horizontal Lifeline Termination Device — 7608008
6. Metal energy absorber — 7401013



Selection guide:

7401013	7401031	7401032	7401033	7600580
metal energy absorber only	metal energy absorber with 2 shackles, bolts, nuts	metal energy absorber with 2 shackles, bolts, nuts, turnbuckle	metal energy absorber with 3 shackles, bolts, nuts, turnbuckle, thimbles, cable clips	metal energy absorber with 3 shackles, bolts, nuts, turnbuckle, thimbles, cable clips with wedge grip, 2 O-rings

3M™ DBI-SALA® Horizontal Lifelines

These horizontal lifeline systems aren't just easy to use—they're easy to install with the support of our network of certified installers. Call customer service for more information.

- Pre-engineered or customized.
- Provides continuous fall protection.
- Shouldn't conflict with other building safety systems.

See page 31 for more information on 3M™ DBI-SALA® Engineered Systems.



Comparison guide:

	EZ-Line™	Sayflin Synthetic	Sayflin Cable	Multi-Span	SecuraSpan
Maximum Length	60 ft.	100 ft.	100 ft.	180 ft.	600+ ft.
Maximum Span Length	60 ft.	100 ft.	100 ft.	30 ft.	60 ft. w/stanchions, 100 ft.
Minimum Anchorage Strength	5,000 lbs.	5,000 lbs.	5,000 lbs.	5,000 lbs.	5,000 lbs.
Multi-spans Allowed	Yes	No	No	Yes	Yes
Maximum Number of Spans	Many	1	Many	12	Many
Maximum Users on System	6	2	6	2	6
Maximum Users on Span	2	2	2	2	2
420 lb. Capacity	Yes, derate system to single person per span.				

3M™ DBI-SALA® Temporary Multispan Cable Horizontal Lifeline System

Temporary Multispan Cable Horizontal Lifeline Systems are designed for “off-the-shelf” user installation. Custom lengths are available, call customer service for more information.

- Provides 100% continuous fall protection for two workers when they are properly attached to the appropriate lifeline.
- One-piece sleeve bypasses intermediates.
- System includes lifeline, intermediate bracket (one per 30 ft. span), termination hardware, tensioner and two metal energy absorbers.



Selection guide:

	20 ft.	40 ft.	60 ft.	80 ft.	100 ft.	120 ft.	140 ft.	160 ft.	180 ft.
Galvanized	7603020	7603040	7603060	7603080	7603100	7603120	7603140	7603160	7603180
Stainless Steel	Contact Customer Service for part numbers.								

Sayflink sleeve sold separately.

Temporary Multispan Cable Accessories

7608001

Intermediate Bracket

For multi-span systems.



7608002

Sayflink™ Sleeve

For Temporary Multispan Cable Horizontal Lifeline Systems.



Security and confidence at height.



3M™ DBI-SALA® Vertical Systems are designed to complement your ability to work while meeting all applicable OSHA and ANSI standards.

Vertical fall protection systems allow workers to move up and down the entire height of the lifeline rather than having to disconnect and find new tie-off points along the way. Some important considerations when selecting a system include:

Portable or permanent

Temporary jobs require portable systems with synthetic lifelines that can be moved from one location to another. For structures that are accessed often, a permanent solution is a better choice.

Mobile or fixed

Mobile rope grab or ladder sleeve designs automatically follow the user for easy operation. Fixed devices allow the user to fix the unit in place for positioning or restraint applications.

The rules have changed: walking-working surfaces

OSHA's final rule to update general industry walking-working surfaces and fall protection standards (29 CFR 1910.140) means that outdoor advertising fixed ladders over 24 feet will require ladder safety or personal fall arrest systems. It also means that fixed ladder cages and wells must be phased out and replaced by ladder safety or fall arrest systems by 2036.

3M™ DBI-SALA® Lad-Saf™ Flexible Cable Vertical Safety Systems

Adding or upgrading your vertical safety systems just got easier. The new generation of Lad-Saf Systems are reengineered to simplify and speed up the installation process. With up to 72% fewer loose components* than some of our previous models, these lightweight systems are streamlined for easy installation and maintenance on a variety of structures—such as fixed ladders and telecommunication towers.

They have also been designed to meet the requirements of the new ANSI Z359.16 standard when used with our Lad-Saf X2 or X3 sleeve, helping you to stay in compliance with the current fall protection standards.

6116632
Rung, 2 User,
Stainless Steel

6116631
Rung, 2 User,
Galvanized Steel



Convenient

Integrated fall arrest-rated anchor point.

Fast

Installation is easy with fewer loose parts and more robust cable tensioning and termination as compared to our previous systems.

New Pre-Swaged Cable Termination

Durable, high-strength steel construction that allows for easy installation and maintenance-free longevity.

Flexible

Mounting brackets can be used on a variety of fixed ladder styles that may consist of different rung spacings and shapes.

Light

Total system weighs less than our previous 2- and 4-user systems.

Simple

Most configurations use fewer than 13 separate components—up to 72% less than some of our previous models.

Compatible

Designed for use with your Lad-Saf X3 Detachable Cable Sleeve (6160054). Also compatible with Lad-Saf X2 Detachable Cable Sleeve (6160030).

**On specific models.*



Previous
Generation
Cable

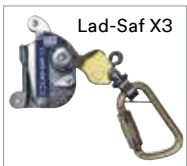

Lad-Saf X3

Introducing

3M™ SecureFit™ Safety
Helmet X5000 Series

Achieve comfort without
compromise while you climb.

3M.com/SecureFitSafetyHelmet



3M™ DBI-SALA® Lad-Saf™ Flexible Cable Vertical Safety Systems

6116633

Rung, 4 User,
Galvanized Steel



6116634

Monopole, 4 User,
Galvanized Steel



6116638

Monopole, 4 User,
Stainless Steel

6116618

Telescoping Extension,
4 User, Galvanized Steel

*Ideal to provide access to rooftops
through a roof hatch.*



6116636

Climb Extension,
2 User,
Galvanized Steel



3M™ DBI-SALA® Lad-Saf™ Custom Configured Systems

Choose from each of the following categories:

Top & Bottom Bracket System (both brackets included)

Application	User	Material	Part #
Rung	2 User	Galvanized Steel	6116631
Rung	2 User	Stainless Steel	6116632
Rung	4 User	Galvanized Steel	6116633
Wood Pole	2 User	Galvanized Steel	6116635
Monopole	4 User	Galvanized Steel	6116634
Monopole	4 User	Stainless Steel	6116638
Climb Extension	2 User	Galvanized Steel	6116636
Telescoping Extension	4 User	Galvanized Steel	6116618

Pre-swaged cable at desired length

First 4 numbers in SKU represent the cable type, last 3 numbers represent cable length in feet.

Part #	6104XXX	6105XXX	6106XXX	6107XXX
Diameter	3/8 in. (9.5 mm)	3/8 in. (9.5 mm)	3/8 in. (9.5 mm)	3/8 in. (9.5 mm)
Strand	1 × 7	1 × 7	7 × 19	7 × 19
Steel	Galvanized	Stainless	Galvanized	Stainless
Preformed	Left, Regular Lay	Left, Regular Lay	Right, Regular Lay	Right, Regular Lay
Compliance	RR-W-410	RR-W-410	RR-W-410	RR-W-410
Breaking strength	15,400 lbs. minimum	18,000 lbs. minimum	14,400 lbs. minimum	12,000 lbs. minimum

Lifeline cable offered in:

- 10–100 ft. in 5 ft. increments
- 100–200 ft. in 10 ft. increments
- Over 200 ft. in 20 ft. increments



Cable guides as needed (recommended every 20–40 feet)

Application(s)	Type	Material	Part #
Ladder	Straight Guide	Galvanized Steel	6100400
Ladder	Straight Guide	Stainless Steel	6100457
Ladder	L Guide	Stainless Steel	6100513
Ladder	Straight Guide	Galvanized Steel	6100530
Telescoping & Extension	Straight Guide	Stainless Steel	6100401
Monopole	L Guide	Galvanized Steel	6100515
Wood Pole	Straight Guide	Stainless Steel	6100140

6100400



Additional cable guides available. Contact your 3M Fall Protection Sales Representative for more information.

3M™ DBI-SALA® Lad-Saf™ Complete Systems

Ordering a complete system is now even easier. We offer our most popular systems and lengths including all bracketry, cable, and guides—all in one single SKU.

2-User Ladder System and Cable

Cable Length	20 ft.	30 ft.	40 ft.	50 ft.	60 ft.	70 ft.	80 ft.	90 ft.	100 ft.
Guides Included	0	1	1	1	2	2	2	3	3
Galvanized Steel: • 6116631: Rung, 2-User • 6104XXX: 1 x 7 Swaged Cable, 3/8 in. • 6100400: Cable Guide for fixed ladder (1 per 30 ft.)	6118020	6118030	6118040	6118050	6118060	6118070	6118080	6118090	6118100
Stainless Steel: • 6116632: Rung, 2-User • 6105XXX: 1 x 7 Swaged Cable, 3/8 in. • 6100457: Cable Guide for fixed ladder (1 per 30 ft.)	6119020	6119030	6119040	6119050	6119060	6119070	6119080	6119090	6119100



5901980 Ladder Gate

Designed to help protect you from the dangers (and liability) of unauthorized ladder access.

- Fits ladder widths up to 20 in. (50.8 cm). Mounting hardware included.
- Aluminum construction 8 ft. (2.4 m) height x 36 in. (91.4 cm) width.

Walking-Working Surfaces:

General Industry 29 CFR 1910 Ladder Requirements

Applies to fixed ladders that extend over 24 feet.

Employers must equip existing fixed ladders with a cage, well, ladder safety system or personal fall arrest system.

Effective November 19, 2018

Employers must begin equipping new fixed ladders with a ladder safety system or personal fall arrest system.

Effective November 19, 2018

All fixed ladders must be equipped with a ladder safety system or personal fall arrest system.

Deadline: November 18, 2036

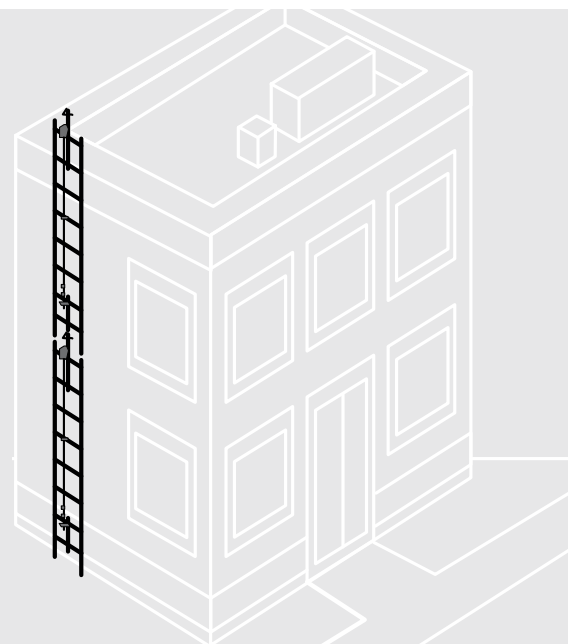

3M™ DBI-SALA® Fixed Ladder SRL Anchor



An alternative option to bring your ladders into compliance is here: the 3M™ DBI-SALA® Fixed Ladder SRL Anchor. At under 30 lbs., this solution adds a convenient tie-off point to existing ladders, helping you meet OSHA's walking working surfaces standard.

Designed with versatile mounting capabilities, the ladder anchor can be positioned to the left or right, and in front or behind the ladder rungs to stay out of the way.

Transportable.

- Under 30 lbs. for ease of transport and installation.

Simple setup.

- Some installations may be made in as little as 5 minutes.

Compatible with your existing fall protection harness.

- Unlike a fixed cable system, this solution doesn't require a front D-ring, which can reduce overall implementation costs.

Versatile installation.

- The ladder anchor can be mounted to the front or behind the ladder with left, right or center alignments.

Designed for durability.

- Available in galvanized or stainless steel.

Compliant to standards.

- Meets 29 CFR OSHA 1910 Walking Working Surfaces Section 1910.27.

3M™ DBI-SALA® Fixed Ladder SRL Anchors

Model #	Length*	Material
6100562	4 ft.	Galvanized
6100563	4 ft.	Stainless Steel
6100564	6 ft.	Galvanized
6100565	6 ft.	Stainless Steel

**Average distance from top rung connection to the anchor point*

All ladder anchor SKUs and associated products available in pallet SKUs. Please contact Customer Service.

Accessories

3M™ DBI-SALA® Smart Lock Self-Retracting Lifeline

1,350 lb. Maximum Arresting Force (MAF)

3503803 20 ft. SRL, Galv. Cable

3503804 20 ft. SRL, SS Cable

3503800 30 ft. SRL, Galv. Cable

3503801 30 ft. SRL, SS Cable

6100566

Ladder Anchor Tagline



Complete Systems

6100568

- 3M™ DBI-SALA® Fixed Ladder SRL Anchor, 4 ft. galvanized
- Smart Lock SRL, 30 ft.
- Tagline

6100569

- 3M™ DBI-SALA® Fixed Ladder SRL Anchor, 4 ft. galvanized
- Smart Lock SRL, 50 ft.
- Tagline



SSB (Speed Sensing Brake) Systems support workers' motions and provides fall protection while climbing tall ladders and towers. Great for on-shore and off-shore drilling platforms.

Added safety

Counterweight includes a runaway brake as a backup safety measure.

Many length options

Durable materials

Block pulley features aluminum housing and system is galvanized for corrosion resistance.

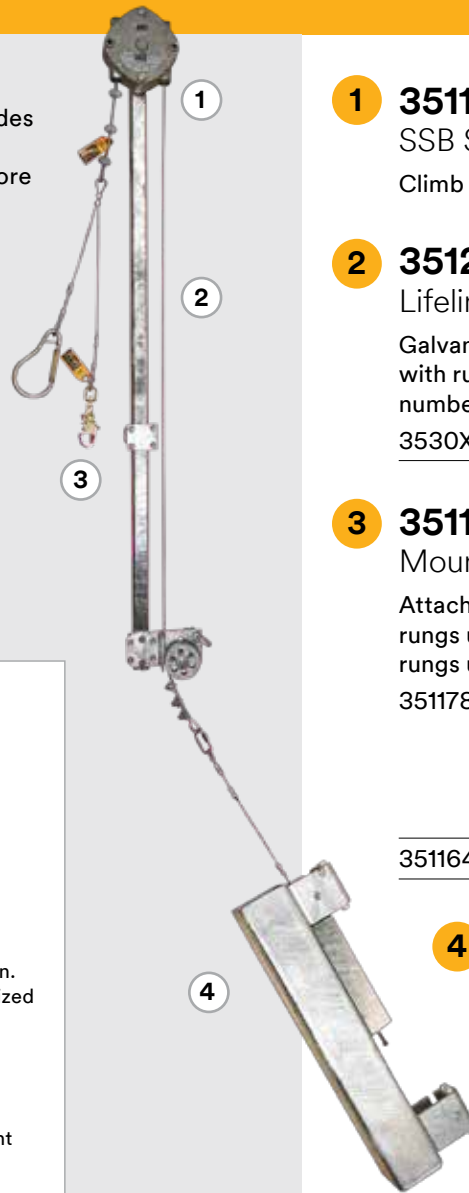
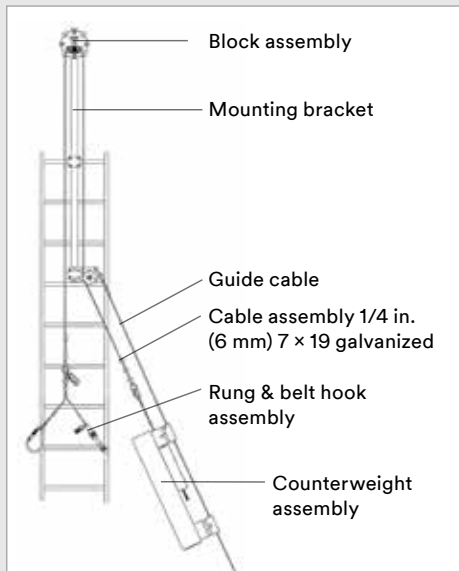

1 3511063
SSB Safety Block
Climb assist main block pulley assembly.

2 3512XXX
Lifeline Assembly
Galvanized 1/4 in. (6.3 cm) 7 × 19 cable assembly with rung and belt hook (last three digits in part number signify length).
3530XXX Stainless Steel Lifeline Assembly

3 3511783
Mounting bracket
Attaches safety block to structure. Fits round rungs up to 3/4 in. (1.9 cm) diameter or square rungs up to 9/16 in. (1.4 cm) per side.
3511785 Mounting bracket, fits round rungs over 3/4 in. (1.9 cm) up to 1-1/2 in. (3.8 cm) diameter or square rungs over 9/16 in. and up to 1-1/2 in. (3.8 cm) per side.

3511645 Rung Belt Assembly

4 3511598
Counterweight Assembly
80 lb. (36.3 kg) counterweight with integrated runaway brake system.

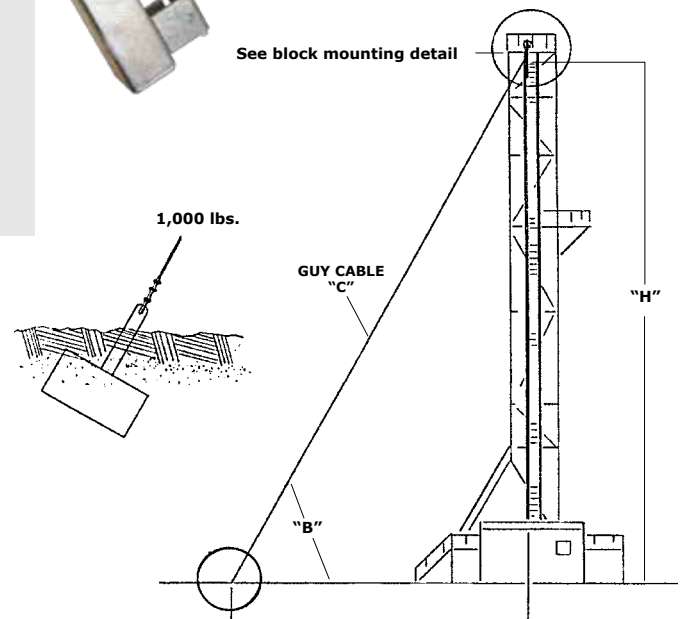

3M™ DBI-SALA® Rope Grabs

5000335

3M™ DBI-SALA®
Lad-Saf™ Mobile
Rope Grab

Detachable design can be attached or removed anywhere along lifeline. For use on 3M approved 5/8 in. (16 mm) polyester/polypropylene rope lifeline. Use with 3 ft. (0.9 m) shock-absorbing lanyard.



5002045 Lad-Saf Rope Grab with attached EZ-Stop™ Shock-Absorbing Lanyard x 3 ft. (0.9 m)

5001442 Lad-Saf Rope Grab for use on 3M approved 3/4 in. (19 mm) polyester/polypropylene rope lifeline x 3 ft. (0.9 m). For use with 3 ft. shock-absorbing lanyard.



1246037

3M™ DBI-SALA®
EZ-Stop™ Rope Adjuster

Installs at top or bottom of the lifeline. For use on 3M approved 5/8 in. (16 mm) rope lifeline. Equipped with RFID.

Rope Lifelines

Various styles and lengths are available to suit any need.



5000338

Lad-Saf Wire Rope Grab

Manual design for use in extremely abrasive or corrosive environments. For use on 3M approved 3/8 in. (9.5 mm) 7 x 19 galvanized or stainless steel cable. Use with 4 ft. (1.2 m) shock-absorbing lanyard.



5000400

Rope Grab Kit

Complete rope grab system in a bag for convenient fall protection compliance on the job. Kit includes:

- Mobile Rope Grab (5000335)
- Shock-Absorbing Lanyard (1246012)
- Lifeline x 50 ft. (1202794)
- Counterweight (5901583)
- Tie-Off Adapter (1003000)
- Carrying Bag (9511597)



5000401 Rope Grab Kit with 100 ft. (30 m) Lifeline (1202844) and Carrying Bag. (9503806)

5901583

Counterweight

5.7 lb. (2.6 kg) flexible counterweight keeps lifeline taut. Nylon construction. Built-in web loop for attachment to lifeline. Compact and portable design. Equipped with RFID.



Polyester/Polypropylene Blended Rope Lifeline

Hook style	Lifeline diameter (inch/mm)	25 ft. (8 m) lifeline	50 ft. (15 m) lifeline	75 ft. (22 m)lifeline	100 ft. (30 m) lifeline	150 ft. (46 m) lifeline
Snap hook at one end	5/8 in. (15.9 mm)	1202742	1202794	1202821	1202844	1202879
	3/4 in. (19.05 mm)	1202739	1202785	1202818	1202838	1202877
Snap hook at both ends	5/8 in. (15.9 mm)	1202740	1202790	1202823	1202842	1202878

Custom sizes available.

3M™ DBI-SALA® Engineered Systems

Flexibility for demanding worksites.

Meet the fall protection needs of your unique worksite with a safety system designed specifically for your application. A 3M certified specialist will help you with options for the selection, installation, training and use of your engineered system. Contact customer service to find a certified specialist to assist you.



Overhead Applications

- Specifically designed to meet the needs of transport and industrial applications.
- Can be used for work at height on trains, trucks, aircraft, crane walkways and loading bays.
- Supports self-retracting lifelines and controlled rate descent devices up to 33.1 lbs. (150.1 kg).
- Allows up to 200 ft. (61 m) single span for one user and up to 100 ft. (30.5) single span for multiple users.*

**The number of system users and span lengths must be verified by the calculation software.*

Wall and Floor Applications

- Engineered lifeline systems can be used for modern building projects, refurbishments and industrial safety applications.
- Can be fitted to steel beams, concrete and brickwork.
- Suitable for use on older roof constructions in conjunction with fabricated anchor posts.**

***Not supplied by 3M Fall Protection.*

3504550

3M™ DBI-SALA® Ultra-Lok™
RSQ Self-Retracting Lifeline

Dual mode RSQ allows for a simple, effective rescue should a fall event occur.



3500214

3M™ DBI-SALA® Nano-Lok™
edge Quick-Connect
Self-Retracting Lifeline

8 ft. (2.4 m) lifeline with 3/16 in. (5 mm)
galvanized steel wire rope and aluminum
captive carabiner, quick connector for
harness mounting.



See customizable systems on the following page.

3M™ DBI-SALA® Engineered Systems

Each worksite presents its own set of unique challenges, so fall protection systems need to be adaptable to ensure worker safety. We offer a comprehensive range of fully compliant, practical solutions for most industries.

Roof Safe Cable and Anchor System

Designed with today's modern lightweight roofs in mind, these systems include minimally intrusive fixing procedures. They're designed for installation on a wide variety of roofing structures while protecting their integrity, and feature a variety of components that can be combined in a multitude of configurations.

- Posts can be used as part of an HLL System or as standalone single point rooftop anchors.
- Span up to 15 m (50 ft.) between anchors.
- Provides continuous hands-free access for up to four simultaneous users.



8 mm Permanent Horizontal Lifeline Systems

Cloud based software helps with installation procedures. These systems are easy to calculate, design, specify, install and use.

- Posts can be used as part of an HLL System or as standalone single point rooftop anchors.
- Span up to 15 m (50 ft.) between anchors.
- Provides continuous hands-free access for up to four simultaneous users.



Horizontal Rail Safety Systems

Made of a quality extruded aluminum, these rail systems combine a simple, continuous and functional anchorage system for user safety, along with a low profile design that may help with facility or building aesthetics. In addition to fall protection applications, it has also been used extensively as the primary anchor point for suspended rope access tasks.

- Span up to 15 m (50 ft.) between anchors.
- Posts can be used as part of an HLL System or as an individual anchor point
- Provides continuous hands-free access for up to four simultaneous users.



Contact EngineeredSystems-FP@mmm.com to consult with a certified specialist today.

Roof Safe Cable and Anchor System

A range of system components are available including free-flowing intermediate guides and corner attachments, providing complete hands-free movement across a Horizontal Lifeline System.

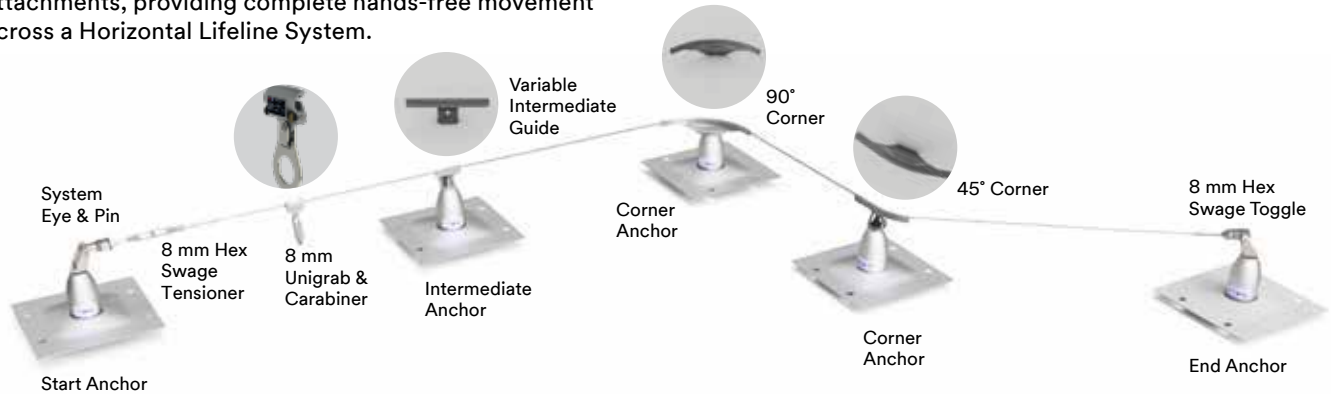

8mm Permanent Horizontal Lifeline Systems

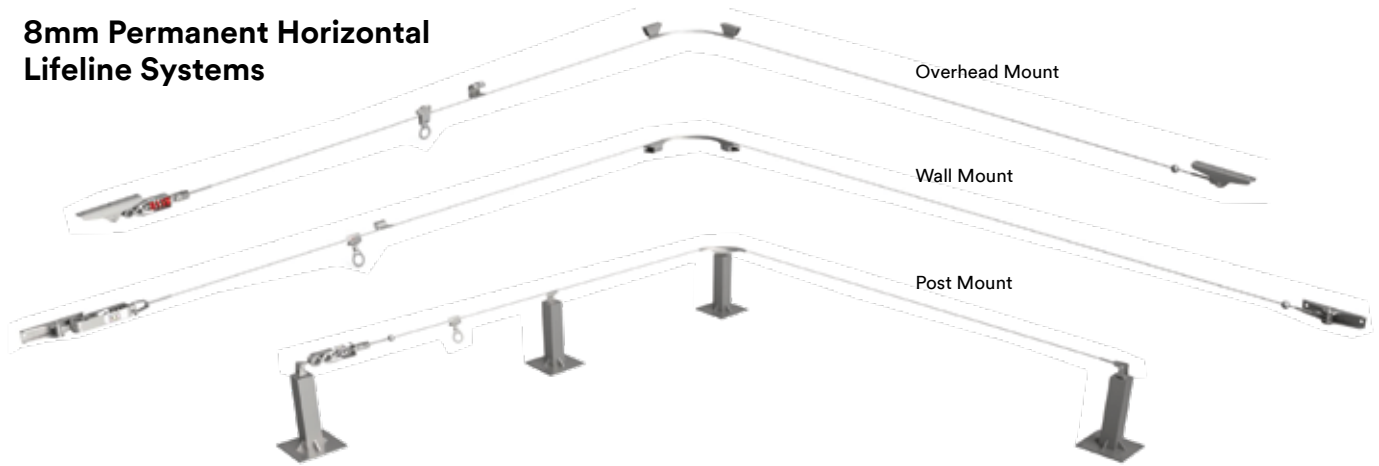

Horizontal Rail Safety Systems

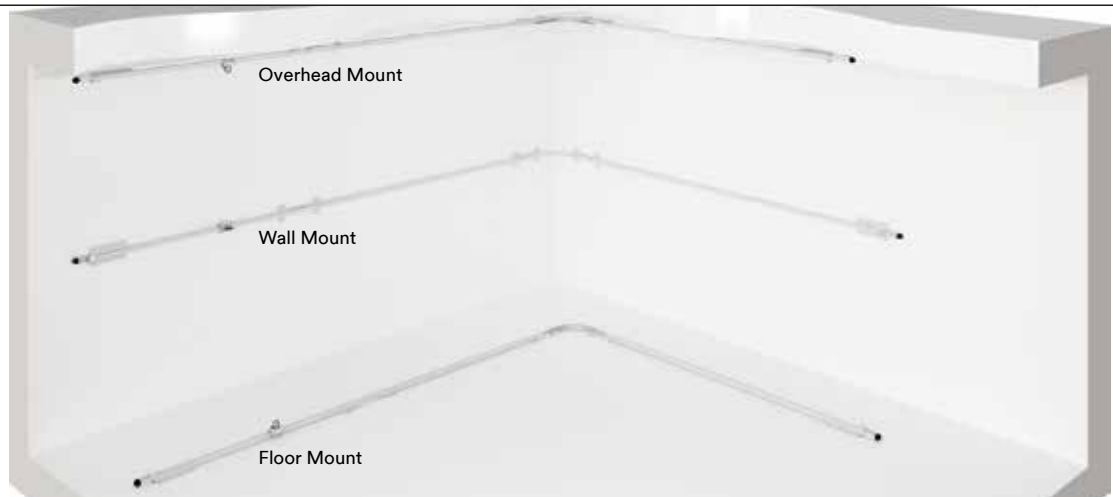

**Scan the QR code and Download the
3M™ Fall Protection Configurator App**



3M™ DBI-SALA® Flexiguard™ Solutions







Unique solutions for unique applications.

No two jobs or job sites are the same. Whether you're working on airplanes or oil rigs, you need a secure anchor point to get the job done. 3M™ DBI-SALA® Flexiguard™ Solutions are designed to help provide safe working areas with overhead anchor points for one or more workers in a variety of challenging situations. These systems are versatile and often mobile. Rugged enough for indoor or outdoor applications, these systems are great for the transportation, construction, oil and gas, mining and utilities industries.

Augment your expectations.

The 3M Fall Protection Configurator App is here—view select 3M™ DBI-SALA® Flexiguard™ Solutions in your work environment, right from your phone. Contact 3M for more information or to schedule a site assessment.

System Type	 Transportation	 Mining	 Defense	 General Industry
Modular Jib System	■	■	■	■
Counterweighted Rail	■	■		
Counterweighted Jib	■	■	■	■
C-Frame	■	■	■	
A-Frame	■	■	■	■
Box Frame	■	■	■	■
Portable Access Ladder	■			
Freestanding Access Ladder	■		■	
Trailer Mounted	■	■		■

■ Primary Application ■ Alternate Application

3M™ DBI-SALA® Flexiguard™ Modular Jib System — M200

Get the coverage you need with this modular fall protection system. Available in both the M100 and M200 Series, the 3M™ DBI-SALA® Flexiguard™ Modular Jib System features a simplified design that enhances worker safety in multiple applications. Increased rail-length configurations improve working coverage while a new design facilitates easier system transport.



M200

Total System Weight	Max. Component Weight	Offset/Reach (A)	Height (B)	Mast Rotation Range	SRL Maximum Arresting Force
12,668 lbs. (5,746 kg)	5,000 lbs. (2,268 kg)	15 ft. (4.6 m) Single User Models 12 ft. (3.7 m) Dual User Models	Up to 30 ft. (9.1 m)	360° for all bases.	1,350 lbs. (6 kN)

1. Choose from 14 interchangeable mast options.

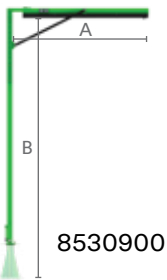

Semi-Fixed Height* Single User Masts

- 8530899 15 – 20 ft. (4.6 – 6 m)
- 8530900 20 – 25 ft. (6 – 7.6 m)
- 8530901 25 – 30 ft. (7.6 – 9.1 m)

8530900

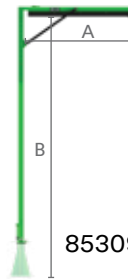

Semi-Fixed Height* Dual User Masts

- 8530902 15 – 20 ft. (4.6 – 6 m)
- 8530903 20 – 25 ft. (6 – 7.6 m)
- 8530904 25 – 30 ft. (7.6 – 9.1 m)

8530903

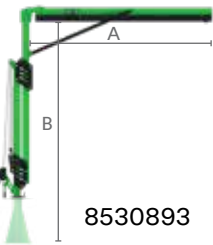

Adjustable Height** Single User Masts

- 8530891 12.3 – 15 ft. (3.8 – 4.6 m)
- 8530892 14.8 – 20 ft. (4.5 – 6.1 m)
- 8530893 17.3 – 25 ft. (5.3 – 7.6 m)
- 8530894 19.8 – 30 ft. (6 – 9.1 m)

8530893

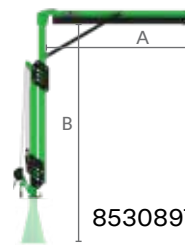

Adjustable Height** Dual User Masts

- 8530895 12.3 – 15 ft. (3.8 – 4.6 m)
- 8530896 14.8 – 20 ft. (4.5 – 6.1 m)
- 8530897 17.3 – 25 ft. (5.3 – 7.6 m)
- 8530898 19.8 – 30 ft. (6 – 9.1 m)

8530897

*Semi-fixed masts have a small amount (5 ft. or 1.5 m) of adjustment to optimize the anchor height during installation.

**Adjustable height masts are adjusted easily using the integrated hand crank winch, or by using a power drill with the optional overload clutch accessory equipped.

2. Choose from 4 interchangeable base options.



8530887

Portable Counterweight Base with concrete fill*

8530886 Without concrete

*Portable Counterweight Base optional leveling jacks sold separately



8530888

Permanent Floor Mounted Base

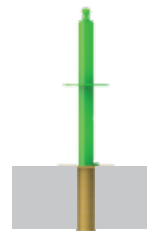

8530889

Permanent Flush Mounted Base

3. Choose your accessories on P.38 ▶

3M™ DBI-SALA® Flexiguard™ Modular Jib System — M100

M100

Total System Weight	Max. Component Weight	Offset/Reach (A)	Height (B)	Mast Rotation Range	SRL Maximum Arresting Force
4,995 lbs (2,266 kg)	3,095 lbs. (1,404 kg)	7.5 ft. (2.3 m)	Up to 30 ft. (9.1 m)	270° with counterweight base. 360° with others.	1,350 lbs. (6 kN)

1. Choose from 7 interchangeable mast options.

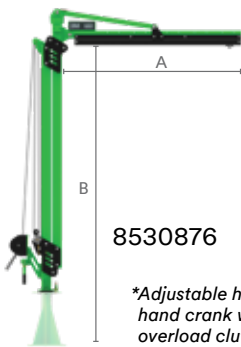

Adjustable Height* Single User Masts

8530874 10 – 15 ft. (3 – 4.6 m)

8530875 2.5 – 20 ft. (3.8 – 6.1 m)

8530876 15 – 25 ft. (4.6 – 7.6 m)

8530876 8530877 17.5 – 30 ft. (5.3 – 9.1 m)

**Adjustable height masts are adjusted easily using the integrated hand crank winch, or by using a power drill with the optional overload clutch accessory equipped.*

Semi-Fixed Height** Single User Masts

8530882 15 – 20 ft. (4.6 – 6 m)

8530883 20 – 25 ft. (6 – 7.6 m)

8530884 25 – 30 ft. (7.6 – 9.1 m)

***Semi-fixed masts offer a small amount (5 ft. or 1.5 m) of adjustment to optimize the anchor height during installation.*

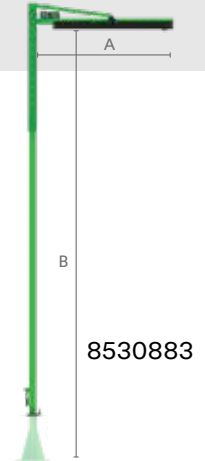

2. Choose from 5 interchangeable base options.



8530870

Portable Counterweight Base with concrete fill*

8530869 Without concrete

**Portable Counterweight Base includes leveling jacks*



8530871

Floor Mounted Base



8530873

Outrigger Base

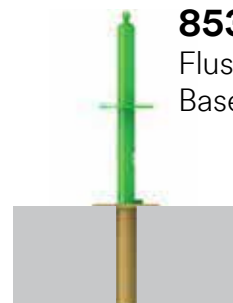

8530872

Flush Mounted Base

3. Choose your accessories on P.38 ▶

3M™ DBI-SALA® Flexiguard™ Modular Jib System Accessories

3. Choose your accessories.



Confined Space & Rescue Pulley Kit

Enables a rescue device to be mounted to the system. Includes mounting brackets and re-direct pulleys. Rescue devices sold separately.

8530885 M100

8530905 M200



Jack Stabilizing Kit

Designed to stabilize and level counterweight base systems on slightly uneven surfaces.
(M200 only)

8530907 M200



Smooth Surface Caster Kit

Allows counterweight base systems to be maneuvered into tight spaces on smooth surfaces.

8530908 M100

8530908 M200



Forklift Pocket Mast Transport Kit

Allows mast to be separated from the base and transported vertically using a forklift.

8530911 M100

8530911 M200



Overload Clutch

Required to raise and lower adjustable masts with a power drill.
(Drill not included)

8512936 M100

8512936 M200



Counterweight Box Lifting Ring Kit

Allows counterweight box to be moved with overhead lifting equipment. Includes four rings per kit. One kit needed per counterweight system.

8530914 M100

8530777 M200

3M™ DBI-SALA® Flexiguard™ Counterweighted Rail System

The Counterweighted Rail System is a portable solution with a counterbalanced design utilizing concrete blocks as ballast. The design allows for optimal positioning and maximum safe working coverage.

- Aluminum glide rail provides continuous fall protection up to 54 ft. long.
- Helps easily create an overhead anchor point for multiple workers.
- Portable system provides flexibility and versatility, letting you position close to the work surface without obstructing the equipment being accessed.
- Systems available with or without concrete counterweight on base.



Counterweighted Jib Rail Models

SKU	Weight (lbs.) w/ concrete	Concrete Counterweight	Overall Height	Users
8517760	11,380	No	23' 7"	2
8517761	11,380	Yes	23' 7"	2
8517762	11,540	No	23' 7"	2
8517763	11,540	Yes	23' 7"	2

Systems with concrete counterweight included ship with two 3,500 lb. concrete blocks.

3M™ DBI-SALA® Flexiguard™ Jib Arms & Rails

The Pivoting Jib Arm & Rail systems are permanently mounted and integrated systems, providing optimal and non-intrusive coverage. These designs clamp to pre-existing structures making them ideal for manufacturing environments and other similar applications.

- Non-base mounted system attaches to supporting, fixed structure (e.g. on I-Beam) on the job site.
- Mounting clamps, plates and hardware included with systems.
- System rotates 180 degrees and locks every 7.5 degrees.



1-User Rated Pivoting Jib Boom Models

SKU	Weight (lbs.)	Overall Height	Overall Width	Rail Length	Max Beam Thickness	Max Beam Width
8530433	560	5' 8"	1' 7"	20' 0"	0' 10"	1' ½"

3M™ DBI-SALA® C-Frame System

The C-Frame System is a mobile solution designed to be positioned manually, or with the use of a tow bar (optional) and service vehicle. The freestanding design utilizes protruding outriggers that extend below the work surface for stability. Available in adjustable height and fixed height models for a wide variety of applications.

- Designed to be moved manually or with a tow bar and service vehicle.
- Designed to be positioned under equipment with minimal ground clearances.
- Adjustable systems allow rail height to be adjusted by manually cranking the winch—allowing for passage under obstructions and building doorways.

2-User Rated Fixed Height Models

SKU	Weight (lbs.)	Overall Height	Anchor Height	Trolley Rail Width
8530842	1,450	22' 0"	20' 0"	15' 0"
8530843	1,500	27' 0"	25' 0"	15' 0"
8530844	1,600	22' 0"	20' 0"	20' 0"
8530845	1,650	27' 0"	25' 0"	20' 0"



2-User Rated Adjustable Height Models

SKU	Weight (lbs.)	Overall Height	Anchor Height	Trolley Rail Width
8517701	1,650	13' 3" – 19' 7"	12' 4" – 18' 8"	10' 0"
8517703	1,970	13' 3" – 19' 7"	12' 2" – 18' 5"	15' 0"
8517705	2,100	13' 3" – 19' 7"	12' 2" – 18' 5"	20' 0"
8517707	2,105	18' 2" – 29' 8"	17' 2" – 28' 7"	15' 0"
8517709	2,236	18' 2" – 29' 8"	17' 2" – 28' 7"	20' 0"
8517711	2,240	23' 4" – 99' 8"	22' 2" – 38' 6"	15' 0"
8517713	2,370	23' 4" – 99' 8"	22' 2" – 38' 6"	20' 0"

Tow Bar Kits

Description	Part #
Tow bar kit (does not include hitch)	8530859
Hitch ball, 2" adapter assembly	8513572
Pintle hitch, adapter assembly	8516187



3M™ DBI-SALA® A-Frame System

The A-Frame System is a mobile solution designed to be positioned manually. The freestanding design straddles the work surface, taking up minimal floor space. Available in adjustable height and fixed height models, this two-user solution can be utilized for a wide variety of applications.

- System contains a single rail rated for two users.
- Glide rail includes two trolleys rated for one user each.
- Systems include heavy-duty leveling jacks.
- Lightweight aluminum construction.*
- Portable design that can be moved easily.
- Four integrated swiveling wheels.

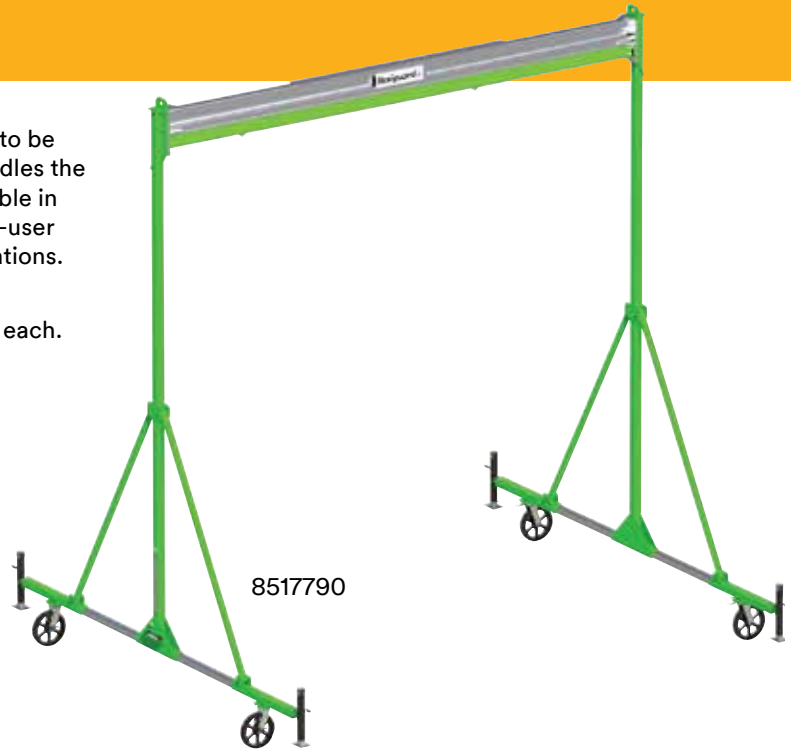

2-User Rated Fixed Height Models

SKU	Weight (lbs.)	Overall Height	Trolley Rail Width
8517790	1,230	17' 0"	15' 0"
8517791	1,380	17' 0"	20' 0"
8517792	1,540	17' 0"	30' 0"
8517793	1,530	22' 0"	15' 0"
8517794	1,680	22' 0"	20' 0"
8517795	2,175	22' 0"	30' 0"
8517796	2,160	32' 0"	15' 0"
8517797	2,240	32' 0"	20' 0"
8517798	2,420	32' 0"	30' 0"

16" rubber molded wheels.

2-User Rated Adjustable Height Models

SKU	Weight (lbs.)	Overall Height	Trolley Rail Width
8517780	3,160	17' 11" – 24' 5"	20' 0"
8517781	3,225	17' 11" – 24' 5"	30' 0"

16" foam filled wheels.



8529744

Converts wheels (qty. 4 required) to 16 in. foam filled pneumatic tires. (Fixed height A-frame systems only.)



9502782

Grounding reel kit.

*Compared to comparable steel construction.

3M™ DBI-SALA® Flexiguard™ Box Frame



The Box Frame System is a mobile solution designed to be positioned manually. The freestanding design straddles the work surface, allowing the fall protection rails to run parallel with the work surface. This system will provide fall protection coverage over a large footprint or area. Available in adjustable height and fixed height models, this two-user solution can be utilized for a wide variety of applications.

Fixed Height Features:

- Provides an effective overhead anchor point.
- Available as a permanent frame or portable for easy relocation.

Adjustable Height Features:

- Adjustable using an overhead crane, forklift or powered system.
- Combines overhead anchorages with mobility in areas with overhead obstructions or door height restrictions.
- Integrated pin-height selection system.

2-User Rated Fixed Height Models

SKU	Weight (lbs.)	Wheel Type	Overall Height	Trolley Rail Width
8530345	1,300	16" pneumatic	15' 0"	Dual rail 15' 6"
8530361	1,500	12" rubber	22' 4"	Single rail 28' 0"
8530427	4,370	16" pneumatic	31' 11"	Dual rail 32' 0"

2-User Rated Adjustable Height Model

SKU	Weight (lbs.)	Wheel Type	Overall Height	Trolley Rail Width
8530288	1,370	12" rubber	13' 4" – 19' 4"	Single rail 28' 0"

3M™ DBI-SALA® Flexiguard™ Portable Access Ladder

The Portable Access Ladder System (PALS) is a mobile solution designed to be positioned manually or with the use of a tow bar (optional) and service vehicle. An adjustable height integrated ladder provides access and egress from elevated work surfaces with an integrated anchor point for added security. The optional rescue kit enables confined space rescue and retrieval capabilities on elevated work surfaces. A variety of other options and accessories make this ladder highly configurable for unique applications.

- Manual height adjustment via winch assembly.
- Multiple height adjustment ranges available.
- All systems include a fall arrest bar for accessing ladder.
- System includes heavy-duty leveling jacks.

2-User Rated Portable Access Ladder System

SKU	Weight (lbs.)	Platform Height	Anchor Height	Base Length
8530852	1,030	8' 2" – 13' 9"	16' 5" – 22' 0"	5' 2"
		7' 8" – 13' 3"	16' 7" – 22' 2"	
8530853	1,046	10' 1" – 15' 8"	18' 3" – 23' 10"	5' 2"
		9' 7" – 15' 2"	18' 6" – 24' 1"	

**When assembled with 8530854, 8530855, 8530856.*

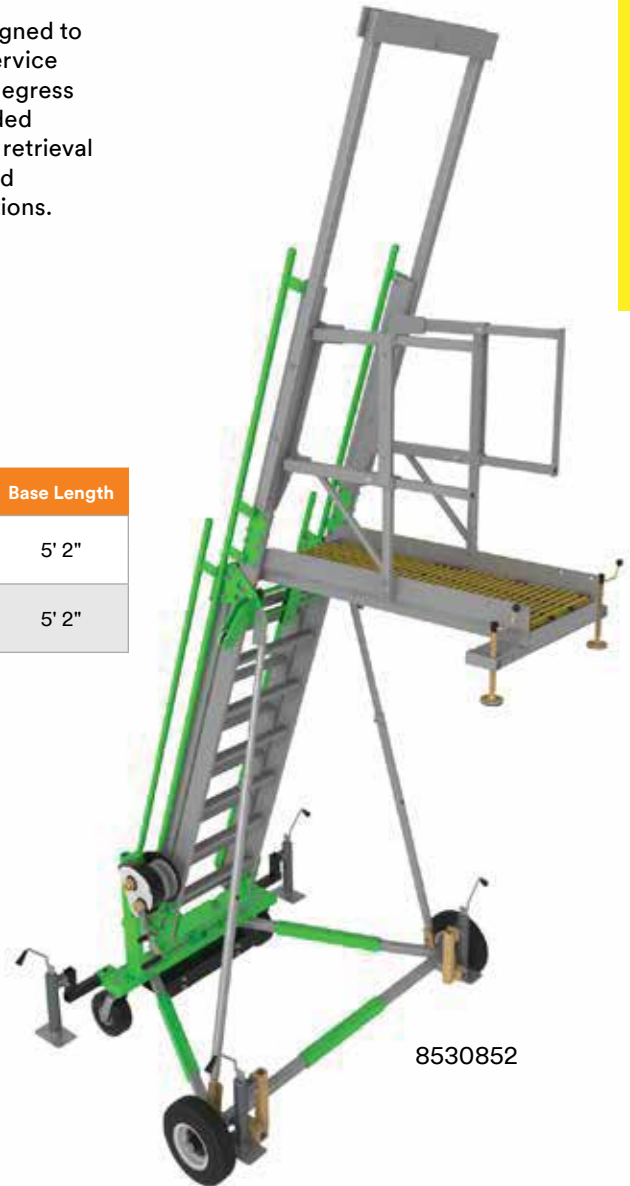

8530852



8530854
Guardrail Cage,
5.5 ft. diameter



8530856
Guardrail add-on kit
for uneven surfaces



8530855
Rescue kit

8515349
Sideways moving kit



8530859
Folding tow bar kit with 2 in. ball
and pintle couplers included



3M™ DBI-SALA® Flexiguard™ Freestanding Access Ladder

This system is a mobile solution designed to be positioned manually or with the use of a tow bar and service vehicle. An adjustable height integrated ladder provides safe access and egress from elevated work surfaces with integrated anchor points supporting up to two workers simultaneously. Adjustable platform heights up to 30 ft. 11 in. provide the ability to serve a multitude of applications.

- Manual height adjustment via winch assembly.
- All systems include a fall arrest bar for accessing ladder.
- System includes leveling jacks.
- Includes 6 ft. working platform with foam bottom and collapsible guardrail handles.

2-User Rated Free-Standing Access Ladder Models

SKU	Weight (lbs.)	Platform Height	Anchor Height	Base Length	Overall Length
8517715	2,056	10' 8" – 15' 8"	19' 7" – 24' 6"	12' 4"	12' 10"
8517717	2,206	14' 5" – 23' 2"	23' 4" – 32' 1"	14' 4"	17' 0"
8517719	2,850	18' 4" – 30' 10"	27' 2" – 39' 9"	17' 4"	20' 10"



3M™ DBI-SALA® Flexiguard™ Trailer Mounted Anchor System

The Trailer Mounted Anchor System is a mobile solution designed to be towed with a service vehicle from application to application. This self-supported design does not require the service vehicle to be attached for use. With an adjustable anchor height of 20 ft. 6 in., and the capacity for two workers, this solution provides maximum versatility.

- Trailer mounted solutions maximize portability and versatility to and from job site.
- System quickly raises and lowers with integrated winch and handle.
- Integrated brake mechanism automatically locks the mast height in the desired position.

2-User Rated Trailer System

SKU	Weight (lbs.)	Tongue Weight	Overall Height	Anchor Height	Overall Length	Cantilever from Trailer	Trailer Length	Trailer Width
8530690	5,500	550	13' 3" – 21' 0"	12' 9" – 20' 6"	17' 7"	3' 0"	14' 5"	7' 0"





Full-Body Harnesses

Harnesses

Whether you are 6' or 60' off the ground, your harness is more than just your safety connection — it's everything.

The right safety harness provides comfort and confidence, and could benefit the user's productivity, as well as gives them versatility to do what needs to be done on the job site. 3M™ DBI-SALA® Harnesses are designed for those who refuse to compromise. The new ExoFit™ X-Series harnesses are outfitted with components that have been developed to help enhance the safety, convenience, and performance for working at height on your jobsite.

We have launched innovations such as the Automatic stand-up dorsal D-ring, Revolving torso adjusters, locking quick-connect buckles, personal SRL adapter, anti-slide dorsal D-ring pad, weight distribution system, suspension trauma straps, and connected safety ID. While many of our harnesses can be used on most jobs, we also manufacture harnesses for specific uses within different industries, like Construction, Oil and Gas, Transportation, Utilities/Telecommunications and Wind Energy.

3M™ DBI-SALA® ExoFit™ X300 Harness

For those who refuse to compromise.

One of our most advanced harnesses just got better. With comfort and fit, it's optimized to help increase the performance and productivity of professionals who take pride in a job done right.

Personal SRL adapter* allows for connection of personal SRLs with confidence and ease.

3M™ Connected Safety ID*

Auto-locking quick connect buckles* to help maintain fit — greatly reducing buckle slide.

Automatic stand-up back D-ring,* conveniently connect faster and easier.

Comfort back pad with built-in durable shoulder caps.

Radio/Cell Phone Holster**

Anti-Slide Dorsal D-Ring Pad

Weight Distribution System* takes weight off your shoulders.**

Revolving torso adjusters* are fast and easy to adjust and lock webbing into place — maintaining a comfortable and safe harness fit.

3M™ Scotchlite™ reflective panels to enhance visibility in low-light environments.

Lightweight Aluminum Tongue-Buckle And Durable Belt

Lightweight Aluminum D-Rings

Comfort hip pad with robust belt loops and rigid belt for tool pouch-carrying convenience.

Auto-Resetting Lanyard Keepers*

Integrated Low-Profile Suspension Trauma Relief Straps*

3M Patented Technology.
****Comes integrated on select models.**

3M™ DBI-SALA® ExoFit™ X-Series Harnesses



ExoFit™ X100 Harness



ExoFit™ X200 Harness



ExoFit™ X300 Harness

B Full-Body Harnesses

Feature	X100	X200	X300
Personal SRL Adapter*		Steel**	Aluminum
Breathable Back Pads	Removable Shoulders (adaptable)	Mesh Shoulders (breathable)	Rubber Shoulders (durable)
Weight Distribution System* Models Available	✓		✓
Automatic Stand-Up D-Ring*		Steel**	Aluminum
Leg Padding			
Secure-Fitting Quick-Connect Buckles		Dual-locking*	Auto-locking*
3M™ Scotchlite™ Reflective Material			Padding Panels
Equipped with Radio/Phone Holster			✓**
Robust Comfort Hip Pad Belt Loops			✓

New ExoFit™ Comfort Harnesses available in a variety of styles:

- ▶ Vest
- ▶ Vest Climbing
- ▶ Vest Positioning
- ▶ Vest Retrieval
- ▶ Vest Climbing/Positioning
- ▶ Vest Climbing/Positioning/Retrieval
- ▶ X100 / X200 / X300 all include Suspension Trauma Straps
- ▶ Construction
- ▶ Construction Climbing
- ▶ Construction Positioning
- ▶ Construction Climbing/Positioning
- ▶ Construction Weight Distribution Positioning
- ▶ Construction Weight Distribution Climbing/Positioning
- ▶ Tower Climbing/Positioning
- ▶ Wind Energy Vest Climbing/Positioning
- ▶ Wind Energy Construction Climbing/Positioning
- ▶ Oil and Gas Vest Climbing/Positioning
- ▶ Oil and Gas Construction Climbing/Positioning
- ▶ Construction Mining

*3M Patented Technology

**Indicates availability on select models.

Designed for ultimate comfort and performance.

Wherever your work takes you, staying comfortably fitted in your safety harness is critical. Designed for comfort and performance, our new line of 3M™ DBI-SALA® ExoFit™ X-Series Harnesses help change the way you work and redefine what you should expect from a safety harness.

3M™ DBI-SALA® ExoFit™ X-Series Harness Sizing Chart X100 | X200 | X300

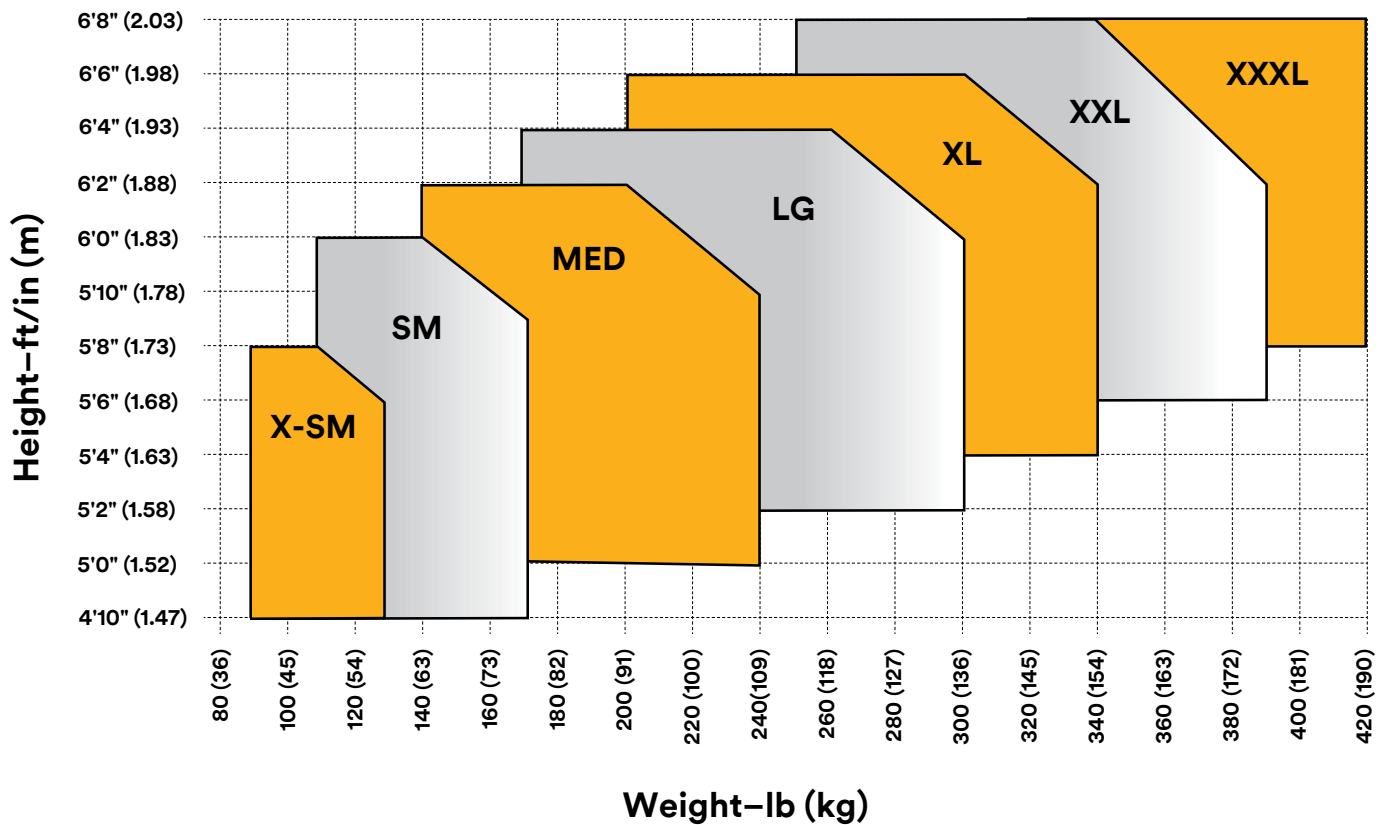

3M™ DBI-SALA® ExoFit™ X100 Safety Harnesses

Gear up with confidence, quality, and performance.

General Industry



Construction



Construction Weight Distribution



Telecommunications



Harness Style	Configuration (D-ring(s), Leg Buckles, Chest Buckle)	WDS ⁴	Small	Medium	Large	X-Large
General Industry						
Comfort Vest ¹	Back, Tongue Buckle, Pass-Thru		1401000	1401001	1401002	1401003
Comfort Vest ¹	Back, Quick-Connect, Quick-Connect		1401020	1401021	1401022	1401023
Comfort Vest Climbing ¹	Back Front, Tongue Buckle, Pass-Thru		1401005	1401006	1401007	1401008
Comfort Vest Climbing ¹	Back Front, Quick-Connect, Quick-Connect		1401025	1401026	1401027	1401028
Comfort Vest Positioning ¹	Back Hip, Tongue Buckle, Pass-Thru		1401010	1401011	1401012	1401013
Comfort Vest Positioning ¹	Back Hip, Quick-Connect, Quick-Connect		1401030	1401031	1401032	1401033
Comfort Vest Climbing/Positioning ¹	Back Front Hip, Tongue Buckle, Pass-Thru		1401015	1401016	1401017	1401018
Comfort Vest Climbing/Positioning ¹	Back Front Hip, Quick-Connect, Quick-Connect		1401035	1401036	1401037	1401038
Construction						
Comfort Construction Positioning ¹	Back Hip, Tongue Buckle, Pass-Thru		1401070	1401071	1401072	1401073
Comfort Construction Positioning ^{1,4}	Back Hip, Tongue Buckle, Pass-Thru	X	1401040	1401041	1401042	1401043
Comfort Construction Positioning ¹	Back Hip, Quick-Connect, Quick-Connect		1401090	1401091	1401092	1401093
Comfort Construction Positioning ^{1,4}	Back Hip, Quick-Connect, Quick-Connect	X	1401050	1401051	1401052	1401053
Comfort Construction Climbing/Positioning ¹	Back Front Hip, Tongue Buckle, Pass-Thru		1401075	1401076	1401077	1401078
Comfort Construction Climbing/Positioning ^{1,4}	Back Front Hip, Tongue Buckle, Pass-Thru	X	1401045	1401046	1401047	1401048
Comfort Construction Climbing/Positioning ¹	Back Front Hip, Quick-Connect, Quick-Connect		1401095	1401096	1401097	1401098
Comfort Construction Climbing/Positioning ^{1,4}	Back Front Hip, Quick-Connect, Quick-Connect	X	1401055	1401056	1401057	1401058
Telecommunications						
Comfort Tower Climbing ¹	Back Front Hip, Tongue Buckle, Quick-Connect		1401140	1401141	1401142	1401143
Retrieval						
Comfort Retrieval ¹	Back Shoulder, Tongue Buckle, Pass-Thru		1401156	1401157	1401158	1401159
Comfort Retrieval ¹	Back Front Hip Shoulder, Tongue Buckle, Pass-Thru		1401161	1401162	1401163	1401164

¹ Available in 2X-Large.

² Available in 3X-Large.

³ Available in X-Small.

⁴ Includes Weight Distribution System (WDS).

3M™ DBI-SALA® ExoFit™ X200 Safety Harnesses

Gear up with confidence, quality, and performance.

General Industry



Construction



Wind Energy



Oil and Gas



Telecommunications



Harness Style	Configuration (D-ring(s), Leg Buckles, Chest Buckle)	Small	Medium	Large	X-Large
General Industry					
Comfort Vest ¹	Back, Tongue Buckle, Pass-Thru	1402000	1402001	1402002	1402003
Comfort Vest ¹	Back, Dual Lock Quick-Connect, Dual Locking Quick-Connect	1402020	1402021	1402022	1402023
Comfort Vest Climbing ¹	Back Front, Tongue Buckle, Pass-Thru	1402005	1402006	1402007	1402008
Comfort Vest Climbing ¹	Back Front, Dual Lock Quick-Connect, Dual Locking Quick-Connect	1402035	1402036	1402037	1402038
Comfort Vest Positioning ¹	Back Hip, Tongue Buckle, Pass-Thru	1402010	1402011	1402012	1402013
Comfort Vest Positioning ¹	Back Hip, Dual Lock Quick-Connect, Dual Locking Quick-Connect	1402040	1402041	1402042	1402043
Comfort Vest Climbing/Positioning ¹	Back Front Hip, Tongue Buckle, Pass-Thru	1402015	1402016	1402017	1402018
Comfort Vest Climbing/Positioning ¹	Back Front Hip, Dual Lock Quick-Connect, Dual Locking Quick-Connect	1402050	1402051	1402052	1402053
Construction					
Comfort Construction Positioning ^{1,3}	Back Hip, Tongue Buckle, Dual Locking Quick-Connect	1402082	1402083	1402084	1402085
Comfort Construction Positioning ^{1,3}	Back Hip, Dual Lock Quick-Connect, Dual Locking Quick-Connect	1402105	1402106	1402107	1402108
Comfort Construction Climbing/Positioning ^{1,3}	Back Front Hip, Tongue Buckle, Quick-Connect	1402088	1402089	1402090	1402091
Comfort Construction Climbing/Positioning ^{1,2}	Back Front Hip, Dual Lock Quick-Connect, Quick-Connect	1402110	1402111	1402112	1402113
Wind Energy					
Comfort Wind Energy Climbing/Positioning ¹	Back Front Hip, Dual Locking Quick-Connect, Dual Locking Quick-Connect	1402125	1402126	1402127	1402128
Comfort Wind Energy Climbing/Positioning ¹	Back Front Hip, Dual Locking Quick-Connect, Dual Locking Quick-Connect	1402130	1402131	1402132	1402133
Oil and Gas					
Comfort Oil and Gas Climbing ¹	Back Hip, Tongue Buckle, Quick-Connect	1402115	1402116	1402117	1402118
Telecommunications					
Comfort Telecom Climbing/Positioning ¹	Back Front Hip, Dual Lock Quick-Connect, Quick-Connect	1402135	1402136	1402137	1402138
Comfort Telecom Climbing/Positioning ¹	Back Front Hip, Tongue Buckle, Quick-Connect	1402140	1402141	1402142	1402143
Cross-Over					
Comfort Cross-Over Climbing ¹	Back Front, Dual Locking Quick-Connect, Dual Locking Quick-Connect	1402156	1402157	1402158	1402159
Comfort Cross-Over Climbing/Positioning ¹	Back Front Hip, Dual Locking Quick-Connect, Dual Locking Quick-Connect	1402160	1402161	1402162	1402163
Retrieval					
Comfort Climbing/Positioning/Retrieval ¹	Back Front Hip Shoulder, Dual Locking Quick-Connect, Dual Locking Quick-Connect	1402150	1402151	1402152	1402153
Comfort Retrieval ¹	Back Shoulder, Dual Locking Quick-Connect, Dual Locking Quick-Connect	1402145	1402146	1402147	1402148

¹ Available in 2X-Large.

² Available in 3X-Large.

³ Available in X-Small.

⁴ Includes Weight Distribution System (WDS).

3M™ DBI-SALA® ExoFit™ X300 Safety Harnesses

Gear up with confidence, quality, and performance.

General Industry



Construction



Construction Weight Distribution



Wind Energy



Telecommunications



Harness Style	Configuration (D-ring(s), Leg Buckles, Chest Buckle)	WDS ⁴	Small	Medium	Large	X-Large
General Industry						
Comfort Vest ¹	Back, Tongue Buckle, Auto-Locking Quick-Connect		1140127	1140128	1140129	1140130
Comfort Vest ^{1,2,3}	Back, Auto-Locking Quick-Connect, Auto-Locking Quick-Connect		1113001	1113004	1113007	1113010
Comfort Vest Climbing ¹	Back Front, Tongue Buckle, Auto-Locking Quick-Connect		1403006	1403007	1403008	1403009
Comfort Vest Climbing ^{1,3}	Back Front, Auto-Locking Quick-Connect, Auto-Locking Quick-Connect		1113031	1113034	1113037	1113040
Comfort Vest Positioning ^{1,3}	Back Hip, Auto-Locking Quick-Connect, Auto-Locking Quick-Connect		1113046	1113049	1113052	1113055
Comfort Vest Positioning ¹	Back Hip, Tongue Buckle, Auto-Locking Quick-Connect		1403011	1403012	1403013	1403014
Comfort Vest Climbing/Positioning ^{1,3}	Back Front Hip, Tongue Buckle, Auto-Locking Quick-Connect		1403017	1403018	1403019	1403020
Comfort Vest Climbing/Positioning ^{1,2,3}	Back Front Hip, Auto-Locking Quick-Connect, Auto-Locking Quick-Connect		1113076	1113079	1113082	1113085
Construction						
Comfort Construction Positioning ^{1,3}	Back Hip, Tongue Buckle, Auto-Locking Quick-Connect		1140181	1140182	1140183	1140184
Comfort Construction Positioning ^{1,3}	Back Hip, Auto-Locking Quick-Connect, Auto-Locking Quick-Connect		1113121	1113124	1113127	1113130
Comfort Construction Climbing/Positioning ^{1,3}	Back Front Hip, Tongue Buckle, Auto-Locking Quick-Connect		1140187	1140188	1140189	1140190
Comfort Construction Climbing/Positioning ^{1,3}	Back Front Hip, Auto-Locking Quick-Connect, Auto-Locking Quick-Connect		1113151	1113154	1113157	1113160
Comfort Construction Positioning ^{1,4}	Back Hip, Auto-Locking Quick-Connect, Auto-Locking Quick-Connect	X	1403098	1403099	1403100	1403101
Comfort Construction Positioning ^{1,4}	Back Hip, Tongue Buckle, Auto-Locking Quick-Connect	X	1403088	1403089	1403090	1403091
Comfort Construction Climbing/Positioning ^{1,4}	Back Front Hip, Tongue Buckle, Auto-Locking Quick-Connect	X	1403093	1403094	1403095	1403096
Comfort Construction Climbing/Positioning ^{1,4}	Back Front Hip, Auto-Locking Quick-Connect, Auto-Locking Quick-Connect	X	1403103	1403104	1403105	1403106
Wind Energy						
Comfort Wind Energy Climbing/Positioning ¹	Back Front Hip, Tongue Buckle, Quick-Connect		1113175	1113176	1113177	1113178
Comfort Wind Energy Climbing/Positioning ¹	Back Front Hip, Auto-Locking Quick-Connect, Auto-Locking Quick-Connect		1113210	1113211	1113212	1113213
Comfort Wind Energy Climbing/Positioning ¹	Back Front Hip, Auto-Locking Quick-Connect, Auto-Locking Quick-Connect		1113215	1113216	1113217	1113218
Comfort Wind Energy Climbing/Positioning ¹	Back Front Hip, Auto-Locking Quick-Connect, Auto-Locking Quick-Connect		1113449	1113450	1113451	1113452
Oil and Gas						
Comfort Oil and Gas Climbing ¹	Back Front, Tongue Buckle, Auto-Locking Quick-Connect		1113290	1113291	1113292	1113293
Comfort Oil and Gas Climbing ¹	Back Front, Tongue Buckle, Pass-Through		1113305	1113306	1113307	1113308
Telecommunications						
Comfort Telecom Climbing/Positioning ¹	Back Front Hip, Auto-Locking Quick-Connect, Auto-Locking Quick-Connect		1113190	1113191	1113192	1113193
Comfort Telecom Climbing/Positioning ¹	Back Front Hip, Tongue Buckle, Auto-Locking Quick-Connect		1113375	1113376	1113377	1113378
Retrieval						
Comfort Retrieval ¹	Back Shoulder, Auto-Locking Quick-Connect, Auto-Locking Quick-Connect		1113061	1113064	1113067	1113070
Mining						
Comfort Mining ¹	Back Front Hip Shoulder, Auto-Locking Quick-Connect, Auto-Locking Quick-Connect		1113195	1113196	1113197	1113199

Belts, Workseats and Accessories



3M™ DBI-SALA® Suspension Trauma Safety Straps

Relief. It can make a big difference when you're suspended in your safety harness. It's why every worker should be equipped with suspension trauma safety straps. They deploy and hook together, allowing a suspended worker to stand up in their harness with one or both feet to relieve downward pressure. They're compact, lightweight and compatible with most harness brands in the field.









Description	Universal
Suspension trauma safety straps, one pair, connects to most harnesses	9501403
Flame-resistant suspension trauma safety straps, one pair, connects to most harnesses	9505712

3M™ DBI-SALA® Harness and Lanyard Bag



Description	Universal
3M™ DBI-SALA® Bag 7-1/2" wide x 6-1/2" deep x 15-1/2" long (19 cm x 16.5 cm x 39.4 cm), holds a harness and lanyard or 50 ft (15.2 m) of 5/8" (0.6 cm) rope	9511597

3M™ DBI-SALA® Fall Protection Accessories

Description	Image	Universal
Weight distribution back bars.		1150530 (XS-M) 1150531 (L-3XL)
Attachment breakaway lanyard keeper plastic ring with Velcro used to “park” lanyard when not in use. Qty. 2.		1150443
D-ring Extension with D-ring at one end, snap hook at other x 18" (46 cm).		1231117
3M™ DBI-SALA® Delta™ Comfort Pad attaches to most harnesses to provide wrap-around comfort.		9501207
3M™ DBI-SALA® ExoFit X100 Leg Pad Kit hook-to-loop attachment		1150528
3M™ DBI-SALA® ExoFitX100 Shoulder Pad hook-to-loop attachment		9515281

3M™ DBI-SALA® ExoFit™ STRATA™ Full-Body Harnesses

Lighten up with the first harness to feature an innovative load distribution system that literally takes the weight off your shoulders.

- Patented design redistributes weight off wearer's shoulders.
- Lightweight aluminum D-rings.
- Easy-linking SRL adapter & standup D-ring simplify connections.
- Mesh padding enhances breathability and comfort.
- Revolving adjusters maintain fit and lock excess webbing in place.
- 420 lb. capacity (Model shown #1112538).
- Quick-connecting buckles enhance adjust-ability.



Triple Action Buckle Tongue Buckle Quick Connect Buckle

3M™ DBI-SALA® ExoFit™ STRATA™ Tower-Climbing Harnesses

These harnesses feature a special removable seat sling used for tower work.

Selection guide:

Chest Buckle	Leg Buckles	D-rings (Back, Hips, Chest, Shoulder)	Small	Medium	Large	XLarge
Triple Action	Triple Action	1B, 1C	1112580	1112581	1112582	1112583
Triple Action	Tongue Buckle	1B, 1C, 2H	1112585	1112586	1112587	1112588

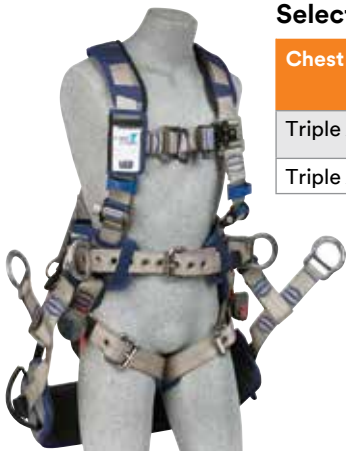

1112588

3M™ DBI-SALA® ExoFit™ STRATA™

Construction-Style Harnesses



1112538

Selection guide:

Chest Buckle	Leg Buckles	D-rings (Back, Hips, Chest, Shoulder)	Small	Medium	Large	XLarge
Quick Connect	Quick Connect	1B, 2H	1112500	1112501	1112502	1112503
Triple Action	Triple Action	1B, 2H	1112535	1112536	1112537	1112538
Triple Action	Triple Action	1B, 1C, 2H	1112540	1112541	1112542	1112543
Triple Action	Triple Action	1B, 1C, 2H, 2S	1112545	1112546	1112547	1112548
Quick Connect	Quick Connect	1B, 2H	1112550	1112551	1112552	1112553
Quick Connect	Quick Connect	1B, 1C	1112555	1112556	1112557	1112558
Quick Connect	Quick Connect	1B, 1C, 2H, 2S	1112560	1112561	1112562	1112563
Triple Action	Tongue Buckle	1B, 2H	1112565	1112566	1112567	1112568
Triple Action	Tongue Buckle	1B, 1C	1112570	1112571	1112572	1112573
Triple Action	Tongue Buckle	1B, 1C, 2H, 2S	1112575	1112576	1112577	1112578
Triple Action	Triple Action	1B	1112665	1112666	1112667	1112668
Triple Action	Tongue Buckle	1B	1112670	1112671	1112672	1112673
Triple Action	Triple Action	1B, 1C, 2H	1112679	—	—	—
Triple Action	Triple Action	1B, 1C, 2H	1114082	1114083	1114084	1114085

3M™ DBI-SALA® ExoFit™ STRATA™

Vest-Style Harnesses

These harnesses include the same great features of the ExoFit™ STRATA™ without the integrated load distribution system.



1112483

Selection guide:

Chest Buckle	Leg Buckles	D-rings (Back, Hips, Chest, Shoulder)	Small	Medium	Large	XLarge
Triple Action	Triple Action	1B	1112475	1112476	1112477	1112478
Triple Action	Triple Action	1B, 2H	1112480	1112481	1112482	1112483
Triple Action	Triple Action	1B, 1C	1112485	1112486	1112487	1112488
Triple Action	Triple Action	1B, 1C, 2H	1112490	1112491	1112492	1112493
Quick Connect	Quick Connect	1B	1112495	1112496	1112497	1112498
Quick Connect	Quick Connect	1B, 1C	1112505	1112506	1112507	1112508
Quick Connect	Quick Connect	1B, 1C, 2H	1112510	1112511	1112512	1112513
Triple Action	Tongue Buckle	1B	1112515	1112516	1112517	1112518
Triple Action	Tongue Buckle	1B, 2H	1112520	1112521	1112522	1112523
Triple Action	Tongue Buckle	1B, 1C	1112525	1112526	1112527	1112528
Triple Action	Tongue Buckle	1B, 1C, 2H	1112530	1112531	1112532	1112533
Triple Action	Tongue Action	1B, 1C, 2H, 2S	1114086	1114087	1114088	1114089

Harnesses

3M™ DBI-SALA® ExoFit™ STRATA™

Construction-Style Harnesses



Description	Small	Medium	Large	XLarge
Tri-Lock Revolver™ Buckles, back and side D-rings	1112535	1112536	1112537	1112537
Duo-Lok™ Quick-Connect Buckles, back and side D-rings	1112550	1112551	1112552	1112553
Tri-Lock Revolver™ Buckles, back, front and side D-rings	1112540	1112541	1112542	1112553
Tongue buckle leg straps, back and side D-rings	1112565	1112566	1112567	1112568

3M™ DBI-SALA® ExoFit™ STRATA™

Tower-Climbing Harnesses



Description	Small	Medium	Large	XLarge
Tri-Lock Revolver Buckles, aluminum front, back and side D-rings, removable seat sling with positioning D-rings	1112580	1112581	1112582	1112583
Tongue buckle leg straps, aluminum front, back and side D-rings, removable seat sling with positioning D-rings	1112585	1112586	1112587	1112588

3M™ DBI-SALA® ExoFit™ STRATA™

Vest-Style Harnesses without LIFTech™ Technology



Description	Small	Medium	Large	XLarge	2X
Aluminum back D-rings, Tri-Lock Revolver™ Quick-Connect Buckles, comfort padding	1112475	1112476	1112477	1112478	1112479
Positioning Harness. Aluminum back and side D-rings, Tri-Lock Revolver™ Quick-Connect Buckles, comfort padding	1112480	1112481	1112482	1112483	1112484
Climbing Harness. Aluminum back, front and side D-rings, tongue buckle leg straps, Tri-Lock Revolver™ chest strap, comfort padding	1112530	1112531	1112532	1112533	1112534
Aluminum back, front, and side D-rings, Tri-Lock Revolver™ Quick-Connect Buckles, comfort padding	1112490	1112491	1112492	1112493	1112494
Aluminum back and side D-rings, tongue buckle leg straps, Tri-Lock Revolver™ chest strap, comfort padding	1112520	1112521	1112522	1112523	1112524
Aluminum back and side D-rings, Duo-Lok™ Quick-Connect Buckles, comfort padding	1112500	1112501	1112502	1112503	1112504

3M™ DBI-SALA® ExoFit™ NEX/ExoFit™ NEX Plus Crossover-Style Harnesses



A front-mounted D-ring makes the crossover-style ideal as a rescue harness and for ladder climbing applications.

Description	Small	Medium	Large	XLarge
Aluminum front and back D-rings, locking quick-connect buckles	1113091	1113094	1113097	1113100
Aluminum front, back and side D-rings, locking quick-connect buckles	1140199	1140200	1140201	1140202

3M™ DBI-SALA® ExoFit™ NEX/ExoFit™ NEX Plus Rope Access and Rescue Harnesses



Complex jobs are easier when your equipment is suited to the task. These multi-use harnesses incorporate components and hardware to optimize rope rescue and industrial rope access work. This makes them ideal for the professional performing rescue and emergency services, industrial rope access and rigging, wind energy and tower maintenance — as well as for arborist activities.

Description	Small	Medium	Large	XLarge
REPEL Technology Webbing, Tech-Lite™ Aluminum Front, Back and Side D-rings, Duo-Lok™ Quick-Connect Buckles and hybrid comfort padding	1113345	1113346	1113347	1113348
REPEL Technology Webbing, Tech-Lite™ Aluminum Front, Back and Side D-rings, Duo-Lok™ Quick-Connect Buckles and hybrid comfort padding	1113370	1113371	1113372	1113373

3M™ DBI-SALA® ExoFit™ Crossover-Style Harnesses



A front-mounted D-ring makes the crossover-style ideal for ladder climbing and rescue applications.

Description	Small	Medium	Large	XLarge
Front and back D-rings, loops for belt, quick-connect buckles	1402156	1402157	1402158	1402159
Front, back and side D-rings, loops for belt, quick-connect buckles	1402161	1402162	1402163	1402164

Harnesses

3M™ DBI-SALA® ExoFit™ NEX Arc Flash

Vest-Style Full-Body Harnesses



Description	Small	Medium	Large	XLarge
Nomex®/Kevlar® fiber web, PVC coated aluminum back D-ring, locking quick-connect buckles, comfort padding	1103085	1103086	1103087	1103088
Nomex®/Kevlar® fiber web, PVC coated aluminum back and side D-rings, locking quick-connect buckles, comfort padding	1103070	1103071	1103072	1103073
Nomex®/Kevlar® fiber web, dorsal web loop and front rescue loops, locking quick-connect buckles, comfort padding	1113325	1113326	1113327	1113328
Nomex®/Kevlar® fiber web, PVC coated aluminum front, back and side D-rings, locking quick-connect buckles, comfort padding	1113330	1113331	1113332	1113333

3M™ DBI-SALA® ExoFit™ NEX Arc Flash

Construction-Style Harnesses

With integrated hip pad and body belt, these harnesses have excellent tool-carrying capabilities, allow work positioning and provide added back support.

Description	Small	Medium	Large	XLarge
Nomex®/Kevlar® fiber web, PVC coated aluminum back and side D-rings, locking quick-connect buckles, sewn-in hip pad and belt, comfort padding	1113315	1113316	1113317	1113318

3M™ DBI-SALA® Delta™

Construction-Style Harnesses



Made for general construction work, these harnesses have tool-carrying capability, a sewn-in hip pad and removable body belt.

Description	Small	Medium	Large	XLarge	Universal
Back and side D-rings, quick-connect buckle legs and chest strap, belt with sewn-in back pad	1110575	1110576	1110577	1110578	–
Vest-style, back and side D-rings, belt with sewn-in back and shoulder pads, tongue buckle leg straps	1102201	1101654	1101655	1101656	–
Front, back and side D-rings, belt and hip pad, tongue buckle leg	1107805	1107802	1107801	1107809	–

3M™ DBI-SALA® Delta™
Vest-Style Harnesses

Vest-style harnesses are widely used, with multiple configurations and connection point options. They're used across a wide variety of industries.



1102000

Selection guide:

Chest Buckle	Leg Buckles	D-rings (Back, Hips, Chest, Shoulder)	Universal Size
Pass-Through	Pass-Through	1B, 2S	1101781
Pass-Through	Tongue Buckle	1B, 2S	1101254
Quick Connect	Quick Connect	1B, 2S	1110602
Pass-Through	Tongue Buckle	1B	1102000
Quick Connect	Quick Connect	1B	1110600
Pass-Through	Pass-Through	1B	1103321
Pass-Through	Tongue Buckle	1B, 2H	1102008
Quick Connect	Quick Connect	1B, 2H	1110625
Pass-Through	Pass-Through	1B, 2H	1103875
Quick Connect	Quick Connect	1B, 1C	1102090
Pass-Through	Tongue Buckle	1B, 1C	1107807
Pass-Through	Pass-Through	1B, 1C	1112126
Quick-Connect	Tongue Buckle	1B	1112052
Quick Connect	Pass-Through	1B, Conductive-resistant hardware	1104725

3M™ DBI-SALA® Delta™
Arc Flash Harnesses

Tested to perform in accordance with the stringent ASTM F887 Standard Specification for Personal Climbing Equipment. Features 7,000 lb. nylon web and leather insulators.



1110782

Selection guide:

Chest Buckle	Leg Buckles	Web Loop (Back, Front)	Small	Medium	Large	XLarge
N/A	Pass-Through	1B, 1F	1110754	1110750	1110751	1110752
Quick Connect	Quick Connect	1B, 2F	1110788	1110780	1110781	1110782
Quick Connect	Tongue Buckle	1B, 2F	1110773	1110774	N/A	N/A
Harness Type	Chest Buckle	Leg Buckles	D-rings (Back, Hips, Chest)			Universal Size
Standard	Pass-Through	Pass-Through	1B			1110830
Vest	Quick Connect	Quick Connect	Back Loop			1110820
Crossover	Pass-Through	Pass-Through	1B, 1C, 2H			1110940

1150058

3M™ DBI-SALA® Delta™ Arc Flash Kit

Includes 1110752 Delta Arc Flash Nylon Harness with web loop and Arc Flash Shock-Absorbing Lanyard, 6 ft. (1246305), with bag. (XLarge)

1150054 Kit with Large harness (1110752)



Harnesses

3M™ DBI-SALA® Delta™ Vest

Hi-Vis Reflective and Non-Reflective Workvest Harnesses



Safety is a top priority any time of day. That's why our sleeveless waist-length vests feature a built-in harness for high visibility while working at-height, day or night. They meet CSA Z259.10 for high visibility vests.

Description	Universal
High visibility yellow workvest-style harness, reflective, back D-ring, tongue buckle legs	1107420
High visibility orange workvest-style harness, reflective, back D-ring, tongue buckle legs	1107404
Blue cotton workvest-style harness, non-reflective, back D-ring, tongue buckle legs	1107416

3M™ DBI-SALA® Delta™

Harnesses for Hot Work Use



Featuring heat-resistant and flame-retardant Nomex®/Kevlar® fiber webbing.

Description	Universal
Vest-style, with Nomex®/Kevlar® fiber web, back D-ring, pass-through buckle leg straps, loops for belt	1105475
Crossover-style, front, back and side D-rings, with Nomex®/Kevlar® fiber web, pass-through buckle leg straps, loops for belt	1104775
Vest-style, back D-ring, with Nomex®/Kevlar® fiber web, pass-through buckle leg straps, loops for belt	1104625

Delta™ Resist

Webbing Harness



Protect against grease, oil, dirt and grime with integrated Resist Technology (polyurethane coated webbing).

Description	Universal
Vest-style, back D-ring, tongue buckle legs	110990

Delta™ Harnesses feature detachable shoulder padding (not shown).

Belts, Workseats and Accessories

3M™ DBI-SALA® Workseats

Bosun Chair



Description	Universal
Bosun chair, 12" x 24" x 1" (30.5 cm x 61 cm x 2.5 cm) board, cushion and side snaps	1001190
Bosun chair only, 12" x 24" x 1" (30.5 cm x 61 cm x 2.5 cm) board	1001140

3M™ DBI-SALA®

Tongue Buckle Belts



Description	Small	Medium	Large	XLarge
Tongue buckle belt with side D-rings, 3" (7.6 cm) pad	1000022	1000023	1000024	1000025
Delta™ Tongue Buckle Belt with no D-ring and no pad	1000052	1000053	1000054	1000055
Tongue buckle belt with back D-ring, 3" (7.6 cm) pad	1000002	1000003	1000004	1000005
Tongue buckle belt with floating D-ring, no pad	1000162	1000163	1000164	1000165
ExoFit™ Tongue Buckle Belt with no D-ring, no pad	1000708	1000709	1000716	1000717

3M™ DBI-SALA®

Lineman Belts

Achieve comfort, freedom of movement and ease of use with our ergonomically designed belts.



3M™ DBI-SALA® ExoFit NEX™ Arc Flash Full-Body Harnesses

All the comfort, function and durability you expect, paired with the flame resistance and conductive-resistant construction needed for high voltage electricity or hot-work, like welding. Meets arc flash standard specifications for personal climbing equipment as well as ANSI/ASSP Z359.11 and CSA Z259.10 requirements.

- Flame-resistant Nomex®/Kevlar® webbing rated to 7,000 lbs.
- Revolving adjusters maintain fit and lock excess webbing in place.
- Flame-resistant trauma straps.
- Conductive-resistant, PVC-coated aluminum D-rings.
- Leather insulators help prevent contact between hardware and body.
- Comfortable, lightweight arc flash-rated padding and soft edging.
- Quick-connecting buckles enhance productivity.
- Tested to perform to ASTM F887 for personal climbing equipment.
- 420 lb. capacity (Model shown 1113318).



3M™ DBI-SALA® ExoFit NEX™ Arc Flash Vest-Style Full-Body Harnesses

These harnesses feature Nomex®/Kevlar® fiber webbing, PVC coated D-rings and comfort padding.



1113493

Selection guide:

Harness Type	Chest Buckle	Leg Buckles	D-rings (Back, Hips, Chest, Shoulder)	Small	Medium	Large	XLarge
Standard	Quick Connect	Quick Connect	1B	1103085	1103086	1103087	1103088
Standard	Pass-Through	Pass-Through	1B	1113335	1113336	1113337	1113338
Positioning	Quick Connect	Quick Connect	1B, 2H	1103070	1103071	1103072	1103073
Rescue	Quick Connect	Quick Connect	1B Loop, 2C Loops	1113325	1113326	1113327	1113328
Climbing	Quick Connect	Quick Connect	1B, 1C, 2H	1113330	1113331	1113332	1113333
Construction	Quick Connect	Quick Connect	1B, 1C, 2H	1113490	1113492	1113491	1113493

3M™ DBI-SALA® ExoFit NEX™ Arc Flash

Construction-Style Harnesses

With an integrated hip pad and body belt, these harnesses have excellent tool-carrying capabilities and allow work positioning.



1113369

Selection guide:

Harness Type	Chest Buckle	Leg Buckles	D-rings (Back, Hips, Chest, Shoulder)	Small	Medium	Large	XLarge
Construction	Quick Connect	Quick Connect	1B, 2H	1113315	1113316	1113317	1113318
Tower Climbing AFK	Quick Connect	Quick Connect	1B Loop, 1C, 2H, Seat Sling	1113357	1113358	1113368	1113369

3M™ DBI-SALA® ExoFit NEX™ Arc Flash

Full-Body Harnesses



1113692

Selection guide:

Harness Type	Chest Buckle	Leg Buckles	D-rings (Back, Hips, Chest, Shoulder)	Small	Medium	Large	XLarge
Rope Access/Rescue	Quick Connect	Quick Connect	1B, 2H	1113761	1113762	1113763	1113764
Rope Access/Rescue	Quick Connect	Quick Connect	1B, 2H	1113757	1113758	1113759	1113760
Lineman with 2D Belt	Quick Connect	Quick Connect	1B, 2H	1113676	1113682	1113688	1113692



1113760



1113764



1113786

For Lineman Belts and Harnesses, see page 62.

Lineman Belts and Harnesses

3M™ DBI-SALA® 4D Lineman Belts

Innovative design keeps the center of gravity at the top of the belt for improved safety and optimal comfort.

- 1 Leather construction
- 2 Connections to S-shaped, full floating D-rings
- 3 3M™ DBI-SALA® Cynch-Lok™ Fall-Restricting Device compatible (see 92)
- 4 Distributes weight throughout the contoured, reinforced seat
- 5 Adjustable tongue buckle belt of nylon construction



3M™ DBI-SALA® 2D Lineman Belts

ExoFit NEX™ Arc Flash Harness with 2D Belt				
Small	1113675 – D20	1113676 – D21	1113677 – D22	1113678 – D23
Medium	1113681 – D22	1113682 – D23	1113683 – D24	1113684 – D25
Large	1113688 – D25	1113689 – D26	1113690 – D27	–
XLarge	1113691 – D25	1113692 – D26	1113693 – D27	–

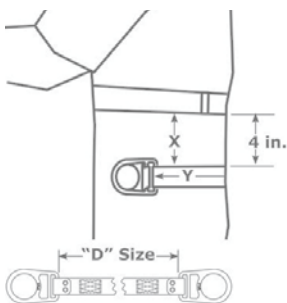

Where to measure to determine the correct “D” size for a Lineman’s Belt:

X = Distance from waist or top of hip bone to where Lineman’s Belt is worn.

Y = Measurement is from front of hip bone around the back to the front of the other hip bone. This measurement is the “D” size.



2D Belt		4D Belt	
D Size	SKU	D Size	SKU
D18	1001379	D18	1001392
D19	1001380	D19	1001393
D20	1001381	D20	1001394
D21	1001382	D21	1001395
D22	1001383	D22	1001396
D24	1001385	D23	1001397
D25	1001386	D24	1001398
D26	1001387	D25	1001399
D27	1001388	D26	1001400
D28	1001389	D27	1001401
D29	1001390	D28	1001402
D30	1001391	D29	1001403
		D30	1001404

D Size (in.)	Belt Sizing (in.)		
	Minimum	Center Hole	Maximum
D18	32	36	40
D19	33	37	41
D20	34	38	42
D21	36	40	44
D22	37	41	45
D23	38	42	46
D24	40	44	48
D25	41	45	49
D26	42	46	50
D27	44	48	52
D28	45	49	53
D29	46	50	54
D30	47	51	55

Understanding leading and sharp edges



The smaller the edge radius, the sharper the edge.

Sharp edges are found in many leading edge applications where the edge is able to cut or damage a traditional lifeline upon contact. Typical I-beams have edge radii that range from .005 in. to .032 in. Do you know how sharp your edges are?



Leading Edge

To visualize a leading edge, imagine a worker installing steel decking on a new building. Now imagine the worker's fall protection system is anchored at foot-level behind him. As the worker moves out and away from the anchor point while installing the decking, the worker is exposed to a potential fall over the edge of the building or the edge of an elevated platform.



Sharp Edge

A sharp edge is one that, for practical purposes, is not rounded and has the potential to cut most types of lifelines. The ANSI Z359.14 standard for sharp edges, for example, involves testing the fall arrest device's lifeline over a piece of steel bar with a radius of no more than 0.005 in. (5 one thousands of an inch). If the lifeline is cut or severely damaged, the device fails the test and does not comply with ANSI.

Unique risks of leading and sharp edges:

1. Increased fall distance

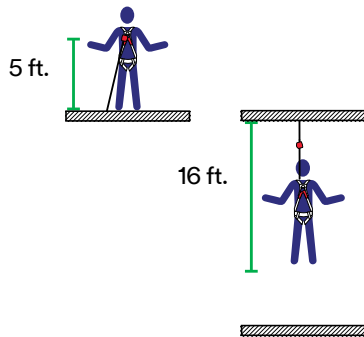

Anchoring at foot-level increases the distance needed for fall clearance.

When workers are attached at foot-level, as they often are in leading edge applications, they will fall farther than they would if they were anchored at shoulder height or above. The required clearance when anchored at foot-level varies by product so make sure to reference the products' user instructions.

2. Lock-up speed

Required time to reach velocity to engage lifeline takes longer because of longer fall distance.

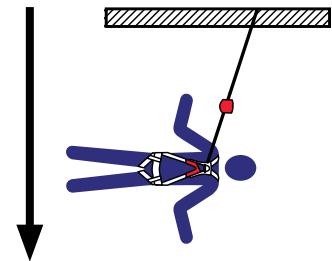

Self-retracting lifelines react to a fall when the lifeline accelerates out of the housing at a certain velocity. When self-retracting lifelines are anchored at foot-level, the lifeline does not achieve the required acceleration during a fall until after the user's D-ring passes over the leading edge and below the level of the anchor. This means the user has already fallen approximately 5 feet before the self-retracting lifeline device will engage to arrest the fall.

3. Increased fall arrest forces

Potentially higher impact to the body when the fall is arrested.



Falling further means the impact on the body through the fall protection system will potentially be greater when the fall is arrested. This is why leading edge and sharp edge rated products contain additional energy-absorbing devices.

4. Increased potential for swing hazards

This could create a sawing action on a lifeline strung taut over a sharp edge.

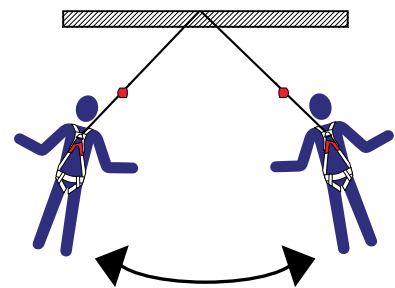

Depending on a worker's position during a fall, they may swing like a pendulum after the fall is arrested. While swinging is a hazard under any circumstances, the danger is compounded if the worker's lifeline is strung taut over a sharp edge and saws back and forth across that edge.

Leading Edge Self-Retracting Lifelines

3M™ DBI-SALA® Smart Lock Leading Edge SRL and Modular Connector

3M testing shows that back D-ring extenders used with standard leading edge SRLs in leading or sharp edge applications could create the potential for a system component to be severed, but not anymore. The Smart Lock Leading Edge SRL is engineered to address this risk and allows for use of a 14 in. modular extension in leading or sharp edge applications.



- Integrated onto existing 3M™ DBI-SALA® Smart Lock Leading Edge SRL (30 ft.)
- Engineered to address risk of use for D-ring extensions in Leading Edge applications.
- Allows for use of 14 in. extension.
- Addresses durability constraints with replaceable shock-pack extender.
- Meets ANSI Z359.14.

Application	Part #	Length	Lifeline Material
Leading Edge SRL with D-ring extension	3503848*	30'	Galvanized Steel
Modular D-ring extension	1246500	14"	-

*D-ring extensions can only be used with these models.



3503848

1246500

C Leading Edge Connectors



Leading Edge Self-Retracting Lifelines

3M™ DBI-SALA® Ultra-Lok™ Leading Edge Self-Retracting Lifelines

This line of retractables includes lengths from 15 ft. to 55 ft. is approved for leading edge work and foot-level tie-off.

- Top swivel limits lifeline twisting.
- Thermoplastic housing.
- Ergonomic cable handle provides added comfort and ease-of-use when making connections.
- Self-locking swivel hook limits lifeline twisting.
- Impact indicator provides visual indication of fall arrest.
- 3,600 lb. gate reduces chances of accidental disengagement (“roll-out”).
- Stainless steel components and anti-ratcheting brake system.



Application	Part #	Length	Lifeline Material
Horizontal (Leading Edge)	3504422	15'	Galvanized Steel
	3504500	30'	Galvanized Steel
	3504600	55'	Galvanized Steel

3504500



3503822

3M™ DBI-SALA® Smart Lock Leading Edge Self-Retracting Lifelines

The 3M™ DBI-SALA® Smart Lock Self-Retracting Lifeline is designed to help increase your productivity and convenience. Significant internal testing was completed to make this product work while reducing the unintentional lockups.

Compared to our existing devices, the new Smart Lock SRL locked up 29% less when tested against 422 work motion profiles.

- Swiveling anchorage and carabiner.
- Built-in handle.
- Magnetic retraction control
- Patent pending dual label system.
- Highly-visible orange energy-absorber cover.



Application	Part #	Length	Lifeline Material
Horizontal (Leading Edge)	3503802	20'	Galvanized Steel
	3503822	30'	Galvanized Steel

Leading Edge Self-Retracting Lifelines

3M™ DBI-SALA® Nano-Lok™ Edge Self-Retracting Lifeline

- Connector provides 360 degrees of rotation and leaves the D-ring open for rescue or other equipment.
- Impact-resistant housing provides durability.
- Global sharp edge icon makes identification of sharp edge product quick and easy.
- 8 ft. (2.4 m) of 3/16 in. (5 mm) galvanized cable lifeline.
- Backpack design stays tight to the harness and helps evenly distribute the unit's weights.
- Backpack-style energy absorber and connector work together to help limit forces on both the worker and the impacted edge.



Selection guide:



		Lifeline hook									SRL
		Tie-back*	Aluminum Rebar Lock Hook	Steel Rebar Lock Hook	Aluminum Rebar Hook	Steel Rebar Hook	Steel Snap Hook	Steel Swivel Snap Hook	Aluminum Captive Carabiner	Aluminum Snap Hook	Part #
Twin Leg		■									3500228
			■								3500231
				■							3500227
					■						3500249
						■					3500246
							■				3500225
								■			3500226
Single Leg									■		3500229
										■	3500230
		■									3500213
			■								3500216
				■							3500212
					■						3500247
						■					3500248
							■				3500210
								■			3500211
									■		3500214
									■	3500215	

*All versions are 8 ft. in length except tie-back models. Tie-back versions are 9 ft.

3M DBI-SALA® Anchors for Leading Edge Applications

Anchors Commonly Used in Leading Edge Applications. Compatible with all versions of Ultra-Lok Leading Edge SRL's (15 ft., 30 ft., 55 ft.) and all Smart Lock Leading Edge SRL's (20 ft. & 30 ft.)



2190073

Standing Seam Roof Anchor

- Installs to flat or sloped roofs, providing an SRL anchorage point.
- Four built-in non-penetrating clamps allow for attachment without damaging the roof.
- Slide on the tube legs fit a variety of seam spacings up to 36 in.



2190074

Construction Roof Anchor

- Installs to rebar ring during pre-cast concrete work utilizing built-in ratcheting securement system—no special tools required.
- Dual-use design allows for use as end anchors for a 2-person temporary 3M™ DBI-SALA® Horizontal Lifeline System.
- For use with 3M™ DBI-SALA® Smart Lock SRL (Sold Separately).



2190071

Swiveling Roof Anchor

- Installs to a variety of sloped or flat wood and metal decking roofs to provide an anchorage point for an SRL or a tie-off point.
- Install with included fastener kit: 16 ea. 1/4-14 × 2-1/2 in. self-tapping screws for steel installation and 8 ea. 1/4 × 2-1/2 in. lag screws for wood.
- Secondary D-ring anchor allows for tie-off with lanyard or install a Horizontal Lifeline between two anchors.

3M™ DBI-SALA® Nano-Lok™ Self-Retracting Lifelines



C Personal Self-Retracting Lifelines



3100483
Dual-Pin style
SRL Connector
(optional)

Light on weight. Heavy on features.

Introducing the new 3M™ DBI-SALA® Nano-Lok™ Personal Self-Retracting Lifeline. Our latest version doesn't just match the performance of the outgoing model—it surpasses it and then some. It's sleeker with a more compact design. It's tougher with a longer lasting cover. It's easier and faster to connect.* All while complying with OSHA's 1910.140 General Industry 4 ft. fall protection rule and ANSI Z359.14 Class A & B standards.

- 900 lb. average arresting force
- 1,350 lb. maximum arresting force
- Installs 60% faster*
- Inspect easily and quickly
- Nitrile rubber cover lasts 4X longer than outgoing mode
- 4 ft. overhead fall clearance per OSHA 1910 General Industry
- ANSI Class A/B units arrest falls within 24" and limit average arresting forces to 900 lbs.
- Knee-level or higher tie-off
- 310 lb. capacity

**Compared to previous generation.*



3M™ DBI-SALA® Nano-Lok™ Personal Self-Retracting Lifelines



3101215
Nano-Lok™
Self-Retracting
Lifeline
With Steel Snap
Hook and Steel
Carabiner x 6 ft.
(1.8 m)



3101228
Nano-Lok™
Self-Retracting
Lifeline
With Steel Snap Hook
and Single-Leg Quick
Connector x 6 ft. (1.8 m)



3101225
Nano-Lok™
Self-Retracting
Lifeline
With Aluminum
Carabiner (Captive
Eye) and Single-Leg
Quick Connector
x 6 ft. (1.8 m)



3101229
Nano-Lok™
Self-Retracting
Lifeline
With Single-Leg
Quick Connector and
Steel Rebar Hook
x 6 ft. (1.8 m)

3M™ DBI-SALA® Nano-Lok™ Twin-Leg Self-Retracting Lifelines



3101280
Nano-Lok™ Twin-Leg
Self-Retracting
Lifeline
With Steel Rebar Snap
Hooks and Quick
Connector x 6 ft. (1.8 m)



3101277
Nano-Lok™ Twin-Leg
Self-Retracting
Lifeline
With Twin-Leg Quick
Connector and two
Aluminum Rebar Hooks
x 6 ft. (1.8 m)



3101473
Nano-Lok™ Twin-Leg
Self-Retracting
Lifeline
With two Aluminum
Locking Rebar Hooks
x 6 ft. (1.8 m)













3101279
Nano-Lok™ Twin-Leg
Self-Retracting
Lifeline
With two Steel Snap
Hooks and Twin-Leg
Connector x 6 ft. (1.8 m)

3M™ DBI-SALA® Nano-Lok™ Personal Self-Retracting Lifelines

Connector Options



		Anchorage Type			Lifeline Hook Options										
					No Connector Included										
Gate Opening	NEW Nano-Lok™ Single Pin Connector 3100480	Steel Carabiner 2000112	Aluminum Carabiner 2000025	3/4 in. (19 mm)		3/4 in. (19 mm)	3/4 in. (19 mm)	2-1/4 in. (57 mm)	2-1/2 in. (62.5 mm)	2-1/2 in. (62.5 mm)	2-1/2 in. (62.5 mm)	2-1/2 in. (62.5 mm)	2-1/4 in. (57 mm)		
Gate Strength	3,600 lb. (16 kN)	3,600 lb. (16 kN)	3,600 lb. (16 kN)	3,600 lb. (16 kN)	3,600 lb. (16 kN)	3,600 lb. (16 kN)	3,600 lb. (16 kN)	3,600 lb. (16 kN)	3,600 lb. (16 kN)	3,600 lb. (16 kN)	3,600 lb. (16 kN)	3,600 lb. (16 kN)	3,600 lb. (16 kN)	Part Number	
ANSI Class A/B	Single Leg	<input type="checkbox"/>	<input type="checkbox"/>	<input type="checkbox"/>	<input type="checkbox"/>	<input checked="" type="checkbox"/>	<input type="checkbox"/>	<input type="checkbox"/>	<input type="checkbox"/>	<input type="checkbox"/>	<input type="checkbox"/>	<input type="checkbox"/>	<input type="checkbox"/>	3101228	
		<input type="checkbox"/>	<input type="checkbox"/>	<input type="checkbox"/>	<input type="checkbox"/>	<input type="checkbox"/>	<input type="checkbox"/>	<input checked="" type="checkbox"/>	<input type="checkbox"/>	<input type="checkbox"/>	<input type="checkbox"/>	<input type="checkbox"/>	<input type="checkbox"/>	3101226	
		<input type="checkbox"/>	<input type="checkbox"/>	<input type="checkbox"/>	<input type="checkbox"/>	<input type="checkbox"/>	<input type="checkbox"/>	<input type="checkbox"/>	<input checked="" type="checkbox"/>	<input type="checkbox"/>	<input type="checkbox"/>	<input type="checkbox"/>	<input type="checkbox"/>	3101225	
		<input type="checkbox"/>	<input type="checkbox"/>	<input type="checkbox"/>	<input type="checkbox"/>	<input type="checkbox"/>	<input type="checkbox"/>	<input type="checkbox"/>	<input type="checkbox"/>	<input checked="" type="checkbox"/>	<input type="checkbox"/>	<input type="checkbox"/>	<input type="checkbox"/>	3101227	
		<input type="checkbox"/>	<input type="checkbox"/>	<input type="checkbox"/>	<input type="checkbox"/>	<input type="checkbox"/>	<input type="checkbox"/>	<input type="checkbox"/>	<input type="checkbox"/>	<input type="checkbox"/>	<input checked="" type="checkbox"/>	<input type="checkbox"/>	<input type="checkbox"/>	3101229	
		<input type="checkbox"/>	<input type="checkbox"/>	<input type="checkbox"/>	<input type="checkbox"/>	<input type="checkbox"/>	<input type="checkbox"/>	<input type="checkbox"/>	<input type="checkbox"/>	<input type="checkbox"/>	<input type="checkbox"/>	<input checked="" type="checkbox"/>	<input type="checkbox"/>	3101468	
		<input type="checkbox"/>	<input type="checkbox"/>	<input type="checkbox"/>	<input type="checkbox"/>	<input type="checkbox"/>	<input type="checkbox"/>	<input type="checkbox"/>	<input type="checkbox"/>	<input type="checkbox"/>	<input type="checkbox"/>	<input type="checkbox"/>	<input checked="" type="checkbox"/>	<input type="checkbox"/>	3101344
		<input type="checkbox"/>	<input type="checkbox"/>	<input type="checkbox"/>	<input type="checkbox"/>	<input type="checkbox"/>	<input type="checkbox"/>	<input type="checkbox"/>	<input type="checkbox"/>	<input type="checkbox"/>	<input type="checkbox"/>	<input type="checkbox"/>	<input type="checkbox"/>	<input checked="" type="checkbox"/>	3101666
		<input type="checkbox"/>	<input checked="" type="checkbox"/>	<input type="checkbox"/>	<input type="checkbox"/>	<input type="checkbox"/>	<input checked="" type="checkbox"/>	<input type="checkbox"/>	<input type="checkbox"/>	<input type="checkbox"/>	<input type="checkbox"/>	<input type="checkbox"/>	<input type="checkbox"/>	<input type="checkbox"/>	3101215
		<input type="checkbox"/>	<input type="checkbox"/>	<input checked="" type="checkbox"/>	<input type="checkbox"/>	<input type="checkbox"/>	<input type="checkbox"/>	<input checked="" type="checkbox"/>	<input type="checkbox"/>	<input type="checkbox"/>	<input type="checkbox"/>	<input type="checkbox"/>	<input type="checkbox"/>	<input type="checkbox"/>	3101214
	<input type="checkbox"/>	<input type="checkbox"/>	<input type="checkbox"/>	<input checked="" type="checkbox"/>	<input type="checkbox"/>	<input type="checkbox"/>	<input type="checkbox"/>	<input checked="" type="checkbox"/>	<input type="checkbox"/>	<input type="checkbox"/>	<input type="checkbox"/>	<input type="checkbox"/>	<input type="checkbox"/>	3101235	
	<input type="checkbox"/>	<input type="checkbox"/>	<input type="checkbox"/>	<input type="checkbox"/>	<input checked="" type="checkbox"/>	<input type="checkbox"/>	<input type="checkbox"/>	<input type="checkbox"/>	<input checked="" type="checkbox"/>	<input type="checkbox"/>	<input type="checkbox"/>	<input type="checkbox"/>	<input type="checkbox"/>	3101236	
	<input type="checkbox"/>	<input checked="" type="checkbox"/>	<input type="checkbox"/>	<input type="checkbox"/>	<input type="checkbox"/>	<input type="checkbox"/>	<input type="checkbox"/>	<input type="checkbox"/>	<input type="checkbox"/>	<input checked="" type="checkbox"/>	<input type="checkbox"/>	<input type="checkbox"/>	<input type="checkbox"/>	3101217	
	<input type="checkbox"/>	<input type="checkbox"/>	<input type="checkbox"/>	<input checked="" type="checkbox"/>	<input type="checkbox"/>	<input type="checkbox"/>	<input type="checkbox"/>	<input type="checkbox"/>	<input type="checkbox"/>	<input type="checkbox"/>	<input checked="" type="checkbox"/>	<input type="checkbox"/>	<input type="checkbox"/>	3101469	
	<input type="checkbox"/>	<input type="checkbox"/>	<input type="checkbox"/>	<input type="checkbox"/>	<input checked="" type="checkbox"/>	<input checked="" type="checkbox"/>	<input type="checkbox"/>	<input type="checkbox"/>	<input type="checkbox"/>	<input type="checkbox"/>	<input type="checkbox"/>	<input type="checkbox"/>	<input type="checkbox"/>	3101252	
	<input type="checkbox"/>	<input type="checkbox"/>	<input type="checkbox"/>	<input type="checkbox"/>	<input checked="" type="checkbox"/>	<input type="checkbox"/>	<input checked="" type="checkbox"/>	<input type="checkbox"/>	<input type="checkbox"/>	<input type="checkbox"/>	<input type="checkbox"/>	<input type="checkbox"/>	<input type="checkbox"/>	3101210	
	<input type="checkbox"/>	<input type="checkbox"/>	<input type="checkbox"/>	<input type="checkbox"/>	<input checked="" type="checkbox"/>	<input type="checkbox"/>	<input type="checkbox"/>	<input checked="" type="checkbox"/>	<input type="checkbox"/>	<input type="checkbox"/>	<input type="checkbox"/>	<input type="checkbox"/>	<input type="checkbox"/>	3101211	
	<input type="checkbox"/>	<input type="checkbox"/>	<input type="checkbox"/>	<input type="checkbox"/>	<input checked="" type="checkbox"/>	<input type="checkbox"/>	<input type="checkbox"/>	<input type="checkbox"/>	<input checked="" type="checkbox"/>	<input type="checkbox"/>	<input type="checkbox"/>	<input type="checkbox"/>	<input type="checkbox"/>	3101254	
	<input type="checkbox"/>	<input type="checkbox"/>	<input type="checkbox"/>	<input type="checkbox"/>	<input checked="" type="checkbox"/>	<input type="checkbox"/>	<input type="checkbox"/>	<input type="checkbox"/>	<input type="checkbox"/>	<input checked="" type="checkbox"/>	<input type="checkbox"/>	<input type="checkbox"/>	<input type="checkbox"/>	3101250	
	<input type="checkbox"/>	<input type="checkbox"/>	<input type="checkbox"/>	<input type="checkbox"/>	<input checked="" type="checkbox"/>	<input type="checkbox"/>	<input type="checkbox"/>	<input type="checkbox"/>	<input type="checkbox"/>	<input type="checkbox"/>	<input type="checkbox"/>	<input type="checkbox"/>	<input checked="" type="checkbox"/>	3101673	
Twin Leg	<input checked="" type="checkbox"/>	<input type="checkbox"/>	<input type="checkbox"/>	<input type="checkbox"/>	<input checked="" type="checkbox"/>	<input type="checkbox"/>	<input type="checkbox"/>	<input type="checkbox"/>	<input type="checkbox"/>	<input type="checkbox"/>	<input type="checkbox"/>	<input type="checkbox"/>	<input type="checkbox"/>	3101279	
	<input checked="" type="checkbox"/>	<input type="checkbox"/>	<input type="checkbox"/>	<input type="checkbox"/>	<input type="checkbox"/>	<input checked="" type="checkbox"/>	<input type="checkbox"/>	<input type="checkbox"/>	<input type="checkbox"/>	<input type="checkbox"/>	<input type="checkbox"/>	<input type="checkbox"/>	<input type="checkbox"/>	3101276	
	<input checked="" type="checkbox"/>	<input type="checkbox"/>	<input type="checkbox"/>	<input type="checkbox"/>	<input type="checkbox"/>	<input type="checkbox"/>	<input checked="" type="checkbox"/>	<input type="checkbox"/>	<input type="checkbox"/>	<input type="checkbox"/>	<input type="checkbox"/>	<input type="checkbox"/>	<input type="checkbox"/>	3101278	
	<input checked="" type="checkbox"/>	<input type="checkbox"/>	<input type="checkbox"/>	<input type="checkbox"/>	<input type="checkbox"/>	<input type="checkbox"/>	<input type="checkbox"/>	<input checked="" type="checkbox"/>	<input type="checkbox"/>	<input type="checkbox"/>	<input type="checkbox"/>	<input type="checkbox"/>	<input type="checkbox"/>	3101277	
	<input checked="" type="checkbox"/>	<input type="checkbox"/>	<input type="checkbox"/>	<input type="checkbox"/>	<input type="checkbox"/>	<input type="checkbox"/>	<input type="checkbox"/>	<input type="checkbox"/>	<input checked="" type="checkbox"/>	<input type="checkbox"/>	<input type="checkbox"/>	<input type="checkbox"/>	<input type="checkbox"/>	3101280	
	<input checked="" type="checkbox"/>	<input type="checkbox"/>	<input type="checkbox"/>	<input type="checkbox"/>	<input type="checkbox"/>	<input type="checkbox"/>	<input type="checkbox"/>	<input type="checkbox"/>	<input type="checkbox"/>	<input checked="" type="checkbox"/>	<input type="checkbox"/>	<input type="checkbox"/>	<input type="checkbox"/>	3101473	
	<input checked="" type="checkbox"/>	<input type="checkbox"/>	<input type="checkbox"/>	<input type="checkbox"/>	<input type="checkbox"/>	<input type="checkbox"/>	<input type="checkbox"/>	<input type="checkbox"/>	<input type="checkbox"/>	<input type="checkbox"/>	<input checked="" type="checkbox"/>	<input type="checkbox"/>	<input type="checkbox"/>	3101471	
	<input checked="" type="checkbox"/>	<input type="checkbox"/>	<input type="checkbox"/>	<input type="checkbox"/>	<input type="checkbox"/>	<input type="checkbox"/>	<input type="checkbox"/>	<input type="checkbox"/>	<input type="checkbox"/>	<input type="checkbox"/>	<input type="checkbox"/>	<input checked="" type="checkbox"/>	<input type="checkbox"/>	3101663	

For ANSI Class B only models, see next page.



Personal Self-Retracting Lifelines

3M™ DBI-SALA® Nano-Lok™ Personal Self-Retracting Lifelines, ANSI Class B

What's a Class B SRL?

Like Class A SRLs, these are OSHA 1926.500 subpart M compliant, but they differ in how quickly they stop a fall (within 54 in. or less), and the subsequent average arrest force on the worker (900 lbs.).

- ANSI Class B device utilizes smart activating brake system to provide 89% fewer unintentional lock-ups*
- Lightweight speed connect system reduces connect and disconnect time by up to 60%*
- Durable nitrile rubber energy absorber cover designed to last 4 times longer*
- 6 ft. fall clearance required on Class B SRLs

Connector Options

		Anchorage Type			Lifeline Hook Options									
					No Connector Included									
		NEW Nano-Lok™ Single Pin Connector 3100480	Steel Carabiner 2000112	Aluminum Carabiner 2000025										
					3/4 in. (19 mm)	3/4 in. (19 mm)	3/4 in. (19 mm)	2-1/4 in. (57 mm)	2-1/2 in. (62.5 mm)	2-1/2 in. (62.5 mm)	2-1/2 in. (62.5 mm)	2-1/4 in. (57 mm)		
					3,600 lb. (16 kN)	3,600 lb. (16 kN)	3,600 lb. (16 kN)	3,600 lb. (16 kN)	3,600 lb. (16 kN)	3,600 lb. (16 kN)	3,600 lb. (16 kN)	3,600 lb. (16 kN)	Part Number	
ANSI Class B	Single Leg	■			■								3101703	
		■					■						3101701	
		■							■				3101702	
	Twin Leg	■								■				3101704
		■									■			3101705
		■										■		3101706
■											■	3101707		

3101703
Nano-Lok™
Self-Retracting
Lifeline, Class B
With single pin
quick connector
and Steel Snap
Hook x 6 ft. (1.8 m)



3101704
Nano-Lok™
Self-Retracting
Lifeline, Class B
With single pin
quick connector
and Steel Rebar
Hook x 6 ft. (1.8 m)



3101706
Nano-Lok™
Twin-Leg
Self-Retracting
Lifeline, Class B
With single pin
quick connector
and Steel Rebar
Hooks x 6 ft. (1.8 m)



3101707
Nano-Lok™
Twin-Leg
Self-Retracting
Lifeline, Class B
With quick
connector and
Aluminum Comfort
Grip Snap Hooks
x 6 ft. (1.8 m)



* Compared to previous generation.

3M™ DBI-SALA® Nano-Lok™ Extended Length Self-Retracting Lifelines

3101582

Nano-Lok™ Extended Length Quick-Connect Self-Retracting Lifeline

With Anchor Hook x 11 ft. (3.35 m)



3101588

Nano-Lok™ Extended Length Order Picker Self-Retracting Lifeline

With Snap Hook x 11 ft. (3.35 m)



3101590

Nano-Lok™ Extended Length Quick-Connect Self-Retracting Lifeline

With Aluminum Rebar Hook x 9 ft. (2.74 m)



3101621

Nano-Lok™ Extended Length Twin-Leg Quick-Connect Self-Retracting Lifeline

With Snap Hook x 11 ft. (3.35 m)



3101624

Nano-Lok™ Extended Length Twin-Leg Quick-Connect Self-Retracting Lifeline

With Aluminum Locking Rebar Hooks x 9 ft. (2.74 m)



3101625

Nano-Lok™ Extended Length Twin-Leg Quick-Connect Self-Retracting Lifeline

With Aluminum Rebar Hooks x 9 ft. (2.74 m)



**Additional Models Available, Contact 3M Fall Protection*

C

Personal Self-Retracting Lifelines

3M™ DBI-SALA® Nano-Lok™ Connected Order Picker Self-Retracting Lifeline

This innovative Fall Protection system senses a worker's presence on an order picking vehicle, verifies their tie-off status, and communicates visual and audible alerts in real time to promote situational awareness and self behavior.

- **Connected Sensor Box**
Overhead unit detects worker's presence on vehicle
- **Connected Aluminum Carabiner**
Sensing carabiner detects if it's connected to worker's harness D-Ring and if the carabiner gate is closed and locked.



3100273

Nano-Lok™ Connected Order



3M™ DBI-SALA® Nano-Lok™ Wrap-Back Self-Retracting Lifelines

Functioning as both a fall protection device and tie-off adapter, it allows safety managers to consolidate multiple equipment capabilities in one versatile solution. The Nano-Lok™ Wrap Back SRL is approved for overhead or foot level tie-off applications.* It connects to beams, rebar walls and other structures that can properly support fall arrest forces—helping protect workers in a wide variety of at-height environments.

- Designed for foot-level anchorage around non-sharp edges
- Wrap back design with specialized Dyneema® web lifeline
- Twin-leg 100% tie-off design
- Built-in pin-style connector for direct attachment to harness
- 8 ft. (2.4 m) of 3/4" (19 mm) wide blue Dyneema® fiber polyester web
- Self-locking snap hook on end of lifeline
- Thermoplastic housing
- Swiveling anchorage loop
- Quick activating speed sensing brake systems
- Integrated backpack style energy absorber
- 3M™ Connected Safety ID (CSID) equipped
- 310 lbs. capacity



3101659
Nano-Lok™
Wrap Back

8 ft. (2.4 m) twin-leg tie-back type lifeline with 3/4 in. (19 mm) wide Dyneema® fiber web and steel rebar hook. Quick connector for harness mounting.

3101658 Single Leg



3101653
Nano-Lok™
Wrap Back

8 ft. (2.4 m) twin-leg tie-back type lifelines with 3/4 in. (19 mm) wide Dyneema® fiber web and tie-back snap hook. Quick connector for harness mounting.

3101654 Single Leg

3M™ DBI-SALA® Nano-Lok™ Arc Flash Self-Retracting Lifelines



Designed specifically for utility applications.

- 8 ft. (2.4 m) working length.
- With Nomex®/Kevlar® fiber web lifeline and reinforced edges for improved wear resistance and durability over standard webbing.
- Features an arc flash industry logo to easily identify the product application.
- Arc flash compliant, tested to 40 cal/cm². Meets ASTM F887.

3101655

Nano-Lok™ for Aerial Work Platforms

4.5 ft. (1.4 m) lifeline with 3/4 in. (19 mm) Nomex®/Kevlar® fiber web and aluminum carabiner. Quick connector for harness mounting.



3101656

Nano-Lok™ for Aerial Work Platforms

3.5 ft. (1.1 m) lifeline with 3/4 in. (19 mm) Nomex®/Kevlar® fiber web and aluminum carabiner, swiveling anchor loop with 13 in. (35 mm) web extension and aluminum snap hook.



3M™ DBI-SALA® Nano-Lok™ Arc Flash Self-Retracting Lifelines



3101526 Nano-Lok™ Arc Flash Self-Retracting Lifeline

3/4 in. (19 mm) Nomex®/Kevlar® fiber webbing and steel snap hook, quick connector for harness mounting x 8 ft. (2.4m).



3101575 Nano-Lok™ Arc Flash Self-Retracting Lifeline

3/4 in. (19 mm) Nomex®/Kevlar® fiber webbing and aluminum carabiner, swiveling anchor loop with 13 in. (33mm) web extension with aluminum snap hook x 8 ft. (2.4m). Best seller for bucket truck applications.



3101536 Nano-Lok™ Arc Flash Twin-Leg Self-Retracting Lifeline

3/4 in. (19 mm) Nomex®/Kevlar® web and steel rebar hooks, quick connector for harness mounting x 8 ft. (2.4m).



3101574 Nano-Lok™ Arc Flash Self-Retracting Lifeline

3/4 in. (19 mm) Nomex®/Kevlar® fiber webbing and web loop, swiveling anchor loop with 13 in. (33mm) web extension with aluminum snap hook x 8 ft. (2.4m).

3M™ DBI-SALA® Nano-Lok™ Arc Flash Self Retracting Lifeline Selection Guide:

	Anchorage type						Lifeline hook							Part Number	
	Single-Leg Connect	Single-Leg Interface	Twin-Leg Interface	Steel Carabiner	Web Leg w/ Aluminum Snap Hook	Steel Snap Hook	Steel Swiveling Snap Hook	Flat Steel Rebar Hook	Steel Rebar Hook with Locking Nose	Aluminum Captive Eye Carabiner	Aluminum Rebar Hook	Aluminum Rebar Hook with Locking Nose	Dielectric Web Loop		11' Tie-Back
8 ft. Single Leg		■				■									3101526
		■					■								3101527
		■						■							3101528
		■							■						3101529
		■								■					3101530
		■									■				3101531
		■										■			3101532
		■			■		■								3101533
6 ft. Twin Leg						■									3101534
			■				■								3101535
			■					■							3101536
			■						■						3101537
			■							■					3101538
			■								■				3101539
			■									■			3101540
Bucket Truck					■									■	3101562
					■									■	3101563
					■										3101565
	■				■										3101655
				■										■	3101574
				■										■	3101575
				■										■	3101656

3M™ DBI-SALA® Nano-Lok™ for Hot Work Use Self-Retracting Lifelines



This SRL was tested to 8 calories, ensuring durability in applications like welding, grinding and torching. It is reinforced with Kevlar® fiber to withstand sparks, weld splatter and other high-heat exposure.

- 6 ft. (1.8 m) working length.
- Universal hot work icon to quickly and easily identify hot work product.
- 3M™ Connected Safety ID (CSID) equipped.



Selection guide:

	Anchorage type			Lifeline hook								Part Number
	Single-Leg Interface	Twin-Leg Interface	Steel Carabiner	Steel Snap Hook	Steel Swiveling Snap Hook	Flat Steel Rebar Hook	Steel Rebar Hook with Loking Nose	Aluminum Captive Eye Carabiner	Aluminum Rebar Hook	Aluminum Rebar Hook with Locking Nose	9' Tie-Back	
8 ft. Single Leg	■			■								3101491
	■				■							3101492
	■					■						3101493
	■						■					3101494
	■							■				3101495
	■								■			3101496
	■									■		3101497
	■		■	■								■
8 ft. Twin Leg		■		■								3101499
		■			■							3101500
		■				■						3101501
		■					■					3101502
		■						■				3101503
		■							■			3101504
		■								■		3101505
		■									■	3101326



3M™ DBI-SALA® Sealed-Blok™ Self-Retracting Lifeline

Grease, dirt and moisture are just part of your job. Keeping them from affecting the performance of your SRL is ours. These sealed SRLs are constructed from heavy-duty, corrosion-resistant materials, and incorporate a patented concept that separates all dynamic components—including the motor spring and brake—from foreign elements.

- 1 Carrying handle**
Built-in design for transport—certified as secondary fall arrest rated anchorage point.
- 2 Galvanized & stainless steel cable**
Abrasion resistant and corrosion-resistant lifeline options.
- 3 Self-locking swivel hook**
 - Limits lifeline twisting
 - Integrated impact indicator
 - 3,600 lb. gate reduces accidental disengagements (“roll-out”)
- 4 Fast Line**
Provides the user with ability to replace the lifeline in the field.
- 5 Pivoting anchorage loop**
Centers the load.
- 6 Aluminum housing**
Provides exceptional strength durability and corrosion resistance.
- 7 Aluminum cast cover**

Sealed design meets IP68 and IP69K rating.



Anti-ratcheting design stays locked on rigid and non-rigid (horizontal lifeline) anchors.

420 lb. weight capacity (All non-RSQ models). Higher capacity for operator and tools (option).

3M™ DBI-SALA® Sealed-Blok™ Self-Retracting Lifelines



Sealed-Blok™ SRL



Automatic Rescue/
Descent Sealed-Blok™



Sealed-Blok™ SRL
with Retrieval



Sealed-Blok™ SRL
with Magnetic
Retraction Control

Product selection guide

	Lifeline material	Hook material	Includes mounting bracket	Retrieval capability	RSQ capacity	310 lb. (141 kg) weight capacity	420 lb. (189 kg) weight capacity	Magnetic Retraction.	15 ft. (4.5 m)	30 ft. (9.1 m)	50 ft. (15.2 m)	85 ft. (25.6 m)	130 ft. (39.6 m)	175 ft. (53.3 m)			
OSHA/ANSI	Galvanized cable	Steel						■	3400825	3400800							
								■			3400900	3400860	3400965	3400650			
				■					■		3400850						
				■					■			3400920	3400870	3400975	3400660		
				■	■				■			3400940	3400910				
				■	■	■			■			3400930	3400885	3400990			
	Stainless steel cable	Stainless steel		■	■						3400853						
				■	■							3400923	3400871	3400976			
										■		3400846					
									■	3400827	3400802						
							■	■					3400902	3400862	3400967	3400652	
													3400932	3400886	3400991		
					■				■			3400852					
					■				■					3400874	3400979	3400661	
	■	■				■				3400942	3400912						
	■	■				■			3400858								
						■				3400942	3400882	3400987					

Other models available; please contact us.

3M™ DBI-SALA® Fast Line Cable Replacement Assemblies



Fast Line allows the lifeline assembly to be replaced out in the field.

3900105

Galvanized Cable with Plated Hook

Fast Line Galvanized Replacement Cable Assembly x 50 ft. (15 m)

3900105 50 ft. (15 m)

3900108 85 ft. (25.5)

3900112 130 ft. (39 m)

3900107

Stainless Steel Cable with Stainless Steel Hook

Fast Line Stainless Steel Replacement Cable Assembly x 50 ft. (15 m)

3900107 50 ft. (15 m)

3900111 85 ft. (25.5 m)

3900114 130 ft. (39 m)



Personal Self-Retracting Lifelines

3M™ DBI-SALA® Ultra-Lok™ Self-Retracting Lifelines

Stainless steel components, an anti-ratcheting brake system and a semi-sealed design.

- 1 Top swivel**
Limits lifeline twisting.
- 2 Thermoplastic housing**
- 3 Ergonomic cable handle**
- 4 Multiple lifeline options**
Galvanized or stainless steel cable, nylon or Nomex®/Kevlar® web, or Vectran™ rope for ultimate jobsite flexibility.
- 5 Self-locking swivel hook**
Limits lifeline twisting.
- 6 Impact indicator**
Provides visual indication of fall arrest.
- 7 3,600 lb. gate**
Reduces chances of accidental disengagement (“roll-out”).



3M™ DBI-SALA® Ultra-Lok™ Self-Retracting Lifelines

Like our Sealed-Blok™, the Ultra-Lok™ Lifeline also extends and retracts, so you can move about freely at normal speeds within a recommended working area. Should a fall occur, a speed-sensing brake system will activate, stopping the fall and reducing the imposed forces to 900 lbs. (4 kN) AAF.



3504500 Ultra-Lok™ Leading Edge SRL

This design incorporates larger diameter 30 ft. (9.1 m) of 7/32 in. cable and an in-line shock absorber for the demands of leading edge applications.

3504505 Ultra-Lok™ RSQ SRL

50 ft. RSQ Automatic Rescue/Descent SRL with 3/16 in. (5 mm) galvanized steel wire rope with swivel snap hook.



3504480 Ultra-Lok™ Self- Retracting Lifeline

1/4" (6 mm) Vectran Synthetic Rope with Swivel Snap Hook.

3501102 Ultra-Lok™ Retrieval SRL







50 ft. (15.2 m) of 3/16 in. (5 mm) galvanized steel wire rope with emergency retrieval winch, mounting bracket, swiveling snap hook and anchorage carabiner.

3M™ DBI-SALA™ Ultra-Lok™ Self-Retracting Lifelines

Lifeline material	Hook style	Hook throat size (in.)	Rated gate capacity (lbs.)	Swivel hook	Leading edge	RSQ	SRL weight capacity (lbs.)	15 ft.	20 ft.	30 ft.	35 ft.	50 ft.	55 ft.	85 ft.
								(4.6 m)	(6.1 m)	(9.1 m)	(9.1 m)	(10.6 m)	(16.7 m)	(26 m)
Galvanized cable	Steel carabiner	5/8	3,600	■			310		3504445	3504446		3504463		
	Steel hook	5/8	3,600	■	■		310	3504422		3504500			3504600	
		3/4	3,600	■		■	310		3504433			3504550		
Stainless steel cable	Stainless steel hook	3/4	3,600	■		■	310					3504552		
				■			310	3504437	3504432		3504452		3504487	
Vectran rope	Steel hook	3/4	3,600	■			310				3504453	3504480		
Retrieval SRLs	Galvanized	3/4	3,600	■			310					3501102		
	Stainless Steel			■			310				3501103			

Other Models available, contact 3M Fall Protection

3M™ DBI-SALA™ Smart Lock Self-Retracting Lifelines

- 
1 Swiveling anchorage & carabiner included
 - 
2 Built-in handle
 Designed for easy transport and support during overhead installation.
 - 
3 Magnetic retraction control
 The lifeline rewinds at an evenly controlled pace, helping reduce the possibility for harm to people or equipment (compared to solutions with gear-based retraction).
 - 
4 Patent pending dual label system
 An extra label stored in the bumper on the lifeline allows users to easily access critical asset information and keeps it protected from damage to help reduce cost of ownership.
 - 
5 Highly-visible orange energy-absorber cover
 Identifies product as meeting Leading Edge standards and allows you to more easily confirm that workers are tied off (Horizontal models).
- 
1,350 lb. Maximum Arresting Force (MAF)
 - 
420 lb. weight capacity



Horizontal (Leading Edge)

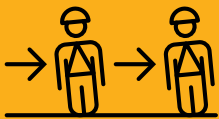

29%

Fewer sudden stops

Enhanced testing programs were performed during the design and qualification of this product to reduce unintentional lockups. Compared to our existing devices the new Smart Lock SRL locked up 29% less when tested against 422 work motion profiles.



Vertical (Overhead)

As low as
4 ft.
fall clearance



Complies with OSHA 1910.140 General Industry

Helps protect general industry workers up to 310 lbs. from falls when working with as little as 4 ft. of fall clearance.



3M™ DBI-SALA® Smart Lock Self-Retracting Lifelines



3503800
Smart Lock SRL – Vertical
30 ft. Galvanized Steel lifeline.



3503805
Smart Lock SRL – Vertical Arc Flash
20 ft. Rope.

3503822
Smart Lock SRL – Horizontal Leading Edge
30 ft. Galvanized Steel lifeline.

3503848
Smart Lock SRL – Horizontal Modular
Works with D-ring extensions.

Learn more about the 3M™ DBI-SALA® Smart Lock Leading Edge SRL and Modular Connector. See page 67.

3M™ DBI-SALA® Smart Lock Self-Retracting Lifelines

Application	Part #	Length	Lifeline Material
Vertical (Overhead)	3503803	20 ft.	Galvanized Steel
	3503804	20 ft.	Stainless Steel
	3503800	30 ft.	Galvanized Steel
	3503801	30 ft.	Stainless Steel
	3503820	35 ft.	Rope
	3503821	35 ft.	Stainless Steel
	3503824	50 ft.	Galvanized Steel
	3503823	50 ft.	Stainless Steel
Horizontal (Leading Edge)	3503802	20 ft.	Galvanized Steel
	3503822	30 ft.	Galvanized Steel
 Arc Flash (Overhead)	3503805	20 ft.	Rope

3M™ DBI-SALA® Smart Lock Leading Edge SRL and Modular Connector

Application	Part #	Length	Description
Horizontal (Leading Edge) with D-ring Extension	3503848	30 ft.	3M™ DBI-SALA® Smart Lock Leading Edge SRL with D-Ring Ext.
	1246500	14 in.	3M™ DBI-SALA® EZ Stop™ LE Shock Pack for Modular Connector SRL

3M™ DBI-SALA® Nano-Lok™ Extended Length Self-Retracting Lifelines

We're advancing the versatility of 3M™ DBI-SALA® Nano-Lok™ SRLs. Available in 9 ft., 11 ft., 15 ft. and now 20 ft. lengths, the family of Nano-Lok™ SRLs combines fall protection with ease-of-use and comfort for even more applications.

- Swiveling anchorage loop limits lifeline twisting.
- Thermoplastic housing designed to withstand demanding worksites.
- As low as 6 ft. of required fall clearance.
- Dyneema® Fiber and Polyester Web Lifeline reduces overall weight and the retractable design provides freedom of movement.
- External energy absorber maintains safe fall arrest forces for users (and tools) up to 420 lbs. (190 kg)
- Impact indicator provides a visual alert that the SRL has been involved in a fall.



3101684



3501694



3103865

3M™ DBI-SALA® Nano-Lok™ XL Self-Retracting Lifelines

Lifeline Material	Length	Connector	Anchor Mount	Part #
Kevlar®	11 ft.	Swiveling Steel Snap Hook	Steel Carabiner	3101684
Dyneema®	20 ft.	Steel Snap Hook	Steel Carabiner	3103865
Dyneema®	20 ft.	Swiveling Steel Snap Hook	Steel Carabiner	3103866
Dyneema®	20 ft.	Aluminum Carabiner	Aluminum Carabiner	3103872
Dyneema®	20 ft.	Swiveling Stainless Steel Snap Hook	Stainless Steel Carabiner	3103873
Galvanized Cable	15 ft.	Swiveling Steel Snap Hook	Steel Carabiner	3501694
Stainless Steel Cable	15 ft.	Swiveling Stainless Steel Snap Hook	Steel Carabiner	3501695

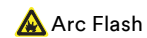

Arc Flash

3M™ DBI-SALA® Shock-Absorbing Lanyards

Meeting industry standards.

When you place your trust in a 3M™ DBI-SALA® Lanyard, you can depend on the fact that every one meets rigorous industry safety standards, including OSHA 29 CFR 1926.502, 1910.140 and ANSI/ASSP Z359.13.

Choosing a lanyard

Look for these features when selecting a lanyard.

- A. Webbing**
Choose your webbing based on the type of conditions you work in. Options include Nomex®/Kevlar® with fiber, polyurethane-coated and cable.
- B. Impact indicators**
Impact indicators let you know if a shock absorber has been involved in a fall, so you can remove it from service.
- C. Connector/hook**
3M™ DBI-SALA® Snap Hooks allow one-handed use and won't pinch thumbs or fingers.
- D. Length**
The standard lanyard length is 6 ft (1.8 m), but other lengths are available.
- E. Shock absorber**
Most shock absorbers keep forces below 900 lbs. (4 kN) AFF and are available in pack or tubular styles.



C Shock-Absorbing Lanyards

Types of 3M™ DBI-SALA® Snap Hooks

All of our lanyards feature 3,600 lb. (16 kN) rated gates.

	Steel Snap Hook	Aluminum Snap Hook	Aluminum Rebar Hook	Flat Steel Rebar Hook	Saflok™ Max Steel Rebar Hook	Saflok™ Tower Hook	Aluminum Rebar Hook with Locking Nose	Steel Rebar Hook with Locking Nose	Wrap Back Hook	Tie-Back Carabiner	Comfort Grip Hook
Gate Opening	3/4 in. (19 mm)	3/4 in. (19 mm)	2-1/4 in. (57 mm)	2-1/2 in. (62.5 mm)	3 in. (76.2 mm)	4-5/16 in. (116.84 mm)	2-1/2 in. (62.5 mm)	2-1/2 in. (62.5 mm)	3/4 in. (19 mm)	3/4 in. (19 mm)	2-1/4 in. (57 mm)
Gate Strength	3,600 lb. (16 kN)	3,600 lb. (16 kN)	3,600 lb. (16 kN)	3,600 lb. (16 kN)	3,600 lb. (16 kN)	3,600 lb. (16 kN)	3,600 lb. (16 kN)	3,600 lb. (16 kN)	3,600 lb. (16 kN)	3,600 lb. (16 kN)	3,600 lb. (16 kN)

3M™ DBI-SALA® Shock-Absorbing Lanyards

Types of Lanyards



Pack-Style Shock-Absorbing Lanyards

These lanyards dissipate energy, limiting the forces on the body in a fall arrest event.



Tubular-Style Shock-Absorbing Lanyards

These lanyards are available in both fixed length and “stretch” style designs.



Twin-Leg Lanyards

Twin-Leg lanyards provide 100% tie-off, allowing users to stay protected when changing locations.



Positioning Lanyards

Designed without shock absorbers for positioning or restraint applications only.



Tie-Back Lanyards

Tie-Back lanyards act as both a connecting means and an anchorage connector when a qualified anchorage connector is not available.



Lanyards for Arc Flash and Hot Work Use

These lanyards are designed with Kevlar® fiber for use in high temperatures or applications requiring arc flash protection.



Lanyards for Foot-Level Tie-Off

Used at the feet, these lanyards allow a 12 ft. (3.7 m) free fall and maintain forces below 1,800 lbs. (8 kN) MAF.



Fall-Restricting Device

Clinches around a wood pole during “cut outs” to help prevent users from falling and allowing them to regain footing.

3M™ DBI-SALA® ShockWave™ 2 Shock-Absorbing Lanyards

Avoid trips and snags with lanyards that expand and contract (6 ft.-4-1/2 ft.) in reaction to movement. They have a built-in impact indicator and limit the average fall arresting forces to 900 lbs. (4 kN)

Selection guide:



1244409

Part #	Single-Leg/ Twin-Leg	Hook 1 (Harness) Material/Style	Hook 2 (Anchor) Material/Style	Hook 3 (Anchor) Material/Style
1244306	Single	Steel/Snap	Steel/Snap	-
1244311	Single	Aluminum/Snap	Aluminum/Rebar Locking Nose	-
1244321	Single	Steel/Snap	Steel/Rebar Locking Nose	-
1244360	Single	Steel/Snap	Steel/Saflok™ Max Rebar	-
1244406	Twin	Steel/Snap	Steel/Snap	Steel/Snap
1244409	Twin	Aluminum/Snap	Aluminum/Rebar Locking Nose	Aluminum/Rebar Locking Nose
1244412	Twin	Steel/Snap	Steel/Rebar Locking Nose	Steel/Rebar Locking Nose

All lanyards are 6 ft. long unless otherwise noted.

3M™ DBI-SALA® Shock-Absorbing Lanyards

3M™ DBI-SALA® ShockWave™ 2

Shock-Absorbing Lanyards

Rescue Lanyards

These lanyards incorporate an integrated D-ring to help facilitate the rescue of a fallen worker.



1244456

Arc Flash Lanyards

Constructed from materials, these lanyards have Nomex®/Kevlar® fiber and are great for high heat environments or for electrical work when arc flash is a concern. Meets arc requirements of ASTM F887.



1244610







Tie-Back Lanyards

When a qualified anchorage connector is not available, a tie-back lanyard acts as both a connecting means and an anchorage connector.



1244650

Selection guide:

Part #	Type	Single-Leg/ Twin-Leg	Hook 1 (Harness) Material/Style	Hook 2 (Anchor) Material/Style	Hook 3 (Anchor) Material/Style
1244456	Rescue	Twin	Steel/Snap, D-ring	Steel/Rebar Locking Nose	Steel/Rebar Locking Nose
1244750	Rescue	Twin	Steel/Snap	Steel/Rebar Locking Nose, D-ring	Steel/Rebar Locking Nose, D-ring
1244455	Rescue	Twin	Steel/Snap, D-ring	Steel/Snap	Steel/Snap
1244459	Rescue	Twin	Steel/Snap, D-ring	Steel/Saflok™ Max Rebar	Steel/Saflok™ Max Rebar
1244751	Rescue	Twin	Aluminum/Snap	Aluminum/Rebar Locking Nose, D-ring	Aluminum/Rebar Locking Nose, D-ring
1244610	Arc Flash 	Single	Steel/Snap	Steel/Snap	-
1244611	Arc Flash 	Single	Web Choker	Steel/Snap	-
1244630	Arc Flash 	Twin	Steel/Snap	Steel/Snap	Steel/Snap
1244631	Arc Flash 	Twin	Web Choker	Steel/Snap	Steel/Snap
1244632	Arc Flash 	Twin	Aluminum/Snap	Aluminum/Rebar Locking Nose	Aluminum/Rebar Locking Nose
1244639	Arc Flash 	Twin	Aluminum/Snap	Steel/Saflok™ Max Rebar	Steel/Saflok™ Max Rebar
1244650	Tie-Back	Single	Steel/Snap	Steel/Tie-back Carabiner	-
1244675	Tie-Back	Twin	Steel/Snap	Steel/Tie-back Carabiner	Steel/Tie-back Carabiner

3M™ DBI-SALA® Shock-Absorbing Lanyards

3M™ DBI-SALA® Force™ 2 Foot-Level Tie Off Shock-Absorbing Lanyards

Selection guide:

Part #	Single-Leg/ Twin-Leg	Leg Material	Hook 1 (Harness) Material/Style	Hook 2 (Anchor) Material/Style	Hook 3 (Anchor) Material/Style
1246143	Twin	Web, Elastic	Steel/Snap	Steel/Saflok™ Max Rebar	Steel/Saflok™ Max Rebar
1246145	Twin	Web, Elastic	Aluminum/Snap	Aluminum/Rebar Locking Nose	Aluminum/Rebar Locking Nose
1246147	Twin	Web, Elastic	Steel/Snap	Steel/Snap	Steel/Snap
1246159	Twin	Web	Steel/Snap	Steel/Rebar Locking Nose	Steel/Rebar Locking Nose
1246161	Twin	Web	Steel/Snap	Steel/Snap	Steel/Snap
1246167	Single	Web	Steel/Snap	Steel/Snap	-
1246273	Twin	Rope	Aluminum/Snap	Aluminum/Rebar Locking Nose	Aluminum/Rebar Locking Nose

Great for when there is no overhead anchorage and your only option is to tie off at your feet. These lanyards can be used for up to a 12 ft. (3.7 m) free fall and limit the forces below 1,800 lbs. (8 kN) MAF.

3M™ DBI-SALA® Wrap Back Tie-Back Lanyards

Selection guide:

Part #	Single-Leg/ Twin-Leg	Leg Material	Hook 1 (Harness) Material/Style	Hook 2 (Anchor) Material/Style	Hook 3 (Anchor) Material/Style
1246075*	Twin	Web	Steel/Snap	Steel/Wrap Back	Steel/Wrap Back
1246080	Twin	Web	Steel/Snap	Steel/Wrap Back	Steel/Wrap Back
1246173*	Single	Web	Steel/Snap	Steel/Wrap Back	-
1246229	Single	Web	Steel/Snap	Steel/Wrap Back	-

These lanyards can help eliminate the need for a separate anchorage connector. They offer a unique 5,000 lb. (22 kN) hook and heavy-duty webbing.



1246229

*Force™2, foot-level tie off.

3M™ DBI-SALA® Force™ 2 Wind Energy Foot-Level Tie Off Lanyards

Selection guide:

Part #	Single-Leg/ Twin-Leg	Leg Material	Hook 1 (Harness) Material/Style	Hook 2 (Anchor) Material/Style	Hook 3 (Anchor) Material/Style
1246030	Twin	Web, Elastic	Steel/Snap	Steel/Rebar Locking Nose	Steel/Rebar Locking Nose
1246032	Twin	Web, Elastic	Aluminum/Snap	Aluminum/Rebar Locking Nose	Aluminum/Rebar Locking Nose
1246152	Twin	Web, Elastic	Steel/Snap	Steel/Saflok™ Max Rebar	Steel/Saflok™ Max Rebar
1246153	Twin	Web, Elastic	Aluminum/Snap	Aluminum/Rebar Locking Nose	Aluminum/Rebar Locking Nose



1246032

3M™ DBI-SALA® EZ-Stop™ Leading Edge Shock-Absorbing Lanyards

Selection guide:

Part #	Type	Single-Leg/ Twin-Leg	Leg Material	Hook 1 (Harness) Material/Style	Hook 2 (Anchor) Material/Style	Hook 3 (Anchor) Material/Style
1246066	Leading Edge	Single	Cable, Vinyl Coated	Steel/Snap	Steel/Snap	-
1246068	Leading Edge	Twin	Cable, Vinyl Coated	Aluminum/Snap	Aluminum/Snap	Aluminum/Snap
1246178	Leading Edge	Twin	Cable, Vinyl Coated	Aluminum/Snap	Aluminum/Rebar Locking Nose	Aluminum/Rebar Locking Nose
1246261	Leading Edge	Single	Cable, Vinyl Coated	Steel/Snap	Steel/Rebar Locking Nose	-

Engineered for sharp edges, these lanyards incorporate edge certified cable construction and offer Force™2 foot-level tie-off ability (for maximum 12 ft. free fall).



1246066

3M™ DBI-SALA® Positioning Web & Rope Lanyards

3M™ DBI-SALA® Positioning Web & Rope Lanyards

Lanyards without shock absorbers, such as rope or web lanyards are designed for positioning or restraint applications.



1231016



1234083

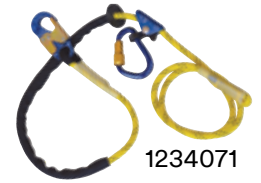

1234071

Selection guide:

Part #	Length	Leg Material	Hook 1 (Harness) Material/Style	Hook 2 (Anchor) Material/Style
1232354	6 ft. (1.8 m)	Rope, Nylon	Steel/Snap	Steel/Snap
1232209	6 ft. (1.8 m)	Rope, Nylon, Adjustable	Steel/Snap	Steel/Snap
1231102	2 ft. (0.6 m)	Web	Steel/Snap	Steel/Snap
1231103	3 ft. (0.9 m)	Web	Steel/Snap	Steel/Snap
1231104	4 ft. (1.2 m)	Web	Steel/Snap	Steel/Snap
1231106	6 ft. (1.8 m)	Web	Steel/Snap	Steel/Snap
1231016	6 ft. (1.8 m)	Web, Adjustable	Steel/Snap	Steel/Snap
1234070	8 ft. (2.4 m)	Rope, Technora® Kernmantle, Adjustable	Steel/Snap	Steel/Rope Adjuster with Carabiner
1234071	8 ft. (2.4 m)	Rope, Technora® Kernmantle, Adjustable	Aluminum/Snap	Aluminum/Rope Adjuster with Carabiner
1234083	8 ft. (2.4 m)	Rope, Technora® Kernmantle, Adjustable	Aluminum/Carabiner	Aluminum/Rope Adjuster with Carabiner
1234080	8 ft. (2.4 m)	Rope, Technora® Kernmantle, Adjustable	Aluminum/Carabiner	Aluminum/Rope Adjuster with Carabiner

C

Shock-Absorbing Lanyards

3M™ DBI-SALA® Chain & Web Rebar Positioning Lanyards

Made of twist link chain or polyester web for strength and durability. A variety of hook options provide a compatible connection to many types of structures.

5920059

Chain Rebar Assembly

With snap hooks and swiveling Saflok™ Max Hook at center x 24 in. (60 cm)

5920059



5920050

Chain Rebar Lanyard

Chain rebar assembly with snap hooks and swiveling flat steel rebar hook at center x 1.7 ft. (52 cm)

5920051

Chain Rebar Lanyard

Chain rebar assembly with snap hooks and swiveling aluminum rebar hook at center x 22 in. (56 cm)

1231380

Web Rebar Assembly

With snap hooks and aluminum rebar hook at center x 18 in. (45 cm)

1231380



1231389

Web Rebar Lanyard

Web rebar assembly with snap hooks and Saflok Max Hook at center x 22 in. (45 cm)

1231520

Web Rebar Lanyard

Web rebar assembly with snap hooks and swiveling aluminum hook at center x 22 in. (56 cm)

3M™ DBI-SALA® Fall-Restricting Devices

3M™ DBI-SALA® Cynch-Lok™ Fall-Restricting Devices

Adjust and cinch around poles during “cut-outs” and hitch-hike poles (move or jump the strap upwards past obstacles) with a hand position consideration. Meets CSA Z259.14 for Type A and AB (dry, wet and icy poles) and ASTM F887.

Selection guide:

Part #	Description	Pole Size Minimum (Dia./Circ.)	Pole Size Maximum (Dia./Circ.)	Weight
1200110	Replacement Strap for Distribution Poles	5-1/2 in./17-1/2 in.	18-1/2 in./58 in.	1.9 lbs. (.86 kg)
1204057	Rope for Distribution Poles	5-1/2 in./17-1/2 in.	18-1/2 in./58 in.	4.8 lbs. (2.1 kg)
1204075	Web for Distribution Poles	5-1/2 in./17-1/2 in.	18-1/2 in./58 in.	4.9 lbs. (2.2 kg)
1200111	Replacement Strap for Transmission Poles	5-1/2 in./17-1/2 in.	30-1/2 in./96 in.	2.4 lbs. (1.1 kg)
1204058	Rope for Transmission Poles	5-1/2 in./17-1/2 in.	30-1/2 in./96 in.	5.3 lbs. (2.4 kg)
1204076	Web for Transmission Poles	5-1/2 in./17-1/2 in.	30-1/2 in./96 in.	5.4 lbs. (2.4 kg)



1204057



1204075

1200115
Cynch-Lok
Replacement Rope
Interior Strap
Weight: 2.9 lbs. (1.3 kg)

1200136
Cynch-Lok
Replacement Web
Interior Strap
Weight: 3 lbs. (1.3 kg)

1204077
Cynch-Lok
Left Carabiner
Conversion
Kit—Web

1204074
Cynch-Lok
Left Carabiner
Conversion
Kit—Rope



**Get in easily.
Get out safely.**

Our extensive line of high quality, rugged rescue and retrieval systems are used to rescue workers in confined spaces.

What to look for in a confined space rescue system:

Ease-of-use

Systems should be easy to set up, use and dismantle.

Mechanical systems

Lifeline types and length are just a few of the options you need to consider.

Durability

Components must be made from quality materials that can endure rough handling and harsh environments.

Versatility

Systems should be adjustable and adaptable to extreme environments. Modular systems allow you to add to your system over time.

Strength

Systems must be rated for your application. Look for maximum strength with minimal weight.

Portability

Systems should be lightweight and easy to transport, set up and store.

3M™ DBI-SALA® Hoist Systems



Engineered with aluminum, 3M™ DBI-SALA® Hoist Systems are adjustable and extendable to meet the specific needs of your job site.

8530352

4-in-1 Davit Guard System

Provides a basic hoist and a passive restraint guardrail system protecting companion workers and bystanders. It offers ample room for worker entry and maneuvering while keeping the confined space opening secure. A standard tie-off point provides a convenient 5,000 lb. (22 kN) anchor point for fall arrest devices where required.



3M™ DBI-SALA® Davit Arm System Components

Variable offset davits are designed for use where multiple offset masts are required. The variable offset masts may be equipped with front mounted and/or back mounted winches or Self-Retracting Lifelines (SRLs) and feature an anchor point rated up to 5,000 lbs. (22 kN). For applications with overhead clearance restrictions, the adjustable height of the variable offset masts can eliminate the need for custom length masts and mast extensions. Quick-connect/release pins allow for fast and easy setup, dismantle and transport.

1 Winch

Davits can be equipped with both primary and secondary (back-up) mechanical devices for added flexibility. Retrieval winches can be used in conjunction with a retrieval SRL or fall protection system to raise and lower personnel and equipment.

2 Quick-Release Mounting Bracket

Simple detent-style winch mounting brackets. (See page 110)

3 Retrieval SRL

Retrieval SRLs offer fall protection as well as emergency retrieval for non-entry rescue.

4 Lower Mast Extensions

Allow the user to adjust the overall anchorage height of the system.

5 Base Options

Several portable and fixed base options are available for complete versatility.

6 Variable Offset Mast

Adjustable length of davit ensures lifelines are always centered over confined space.

7 Built-In Pulleys

Route lifelines of two mechanical devices for smooth, efficient operation.

8 Fall Arrest Anchorage

Up to a 5,000 lb. (22 kN) rated anchor point for fall arrest device.

9 Adjustable Height

Eliminates the need for custom length masts and extensions.

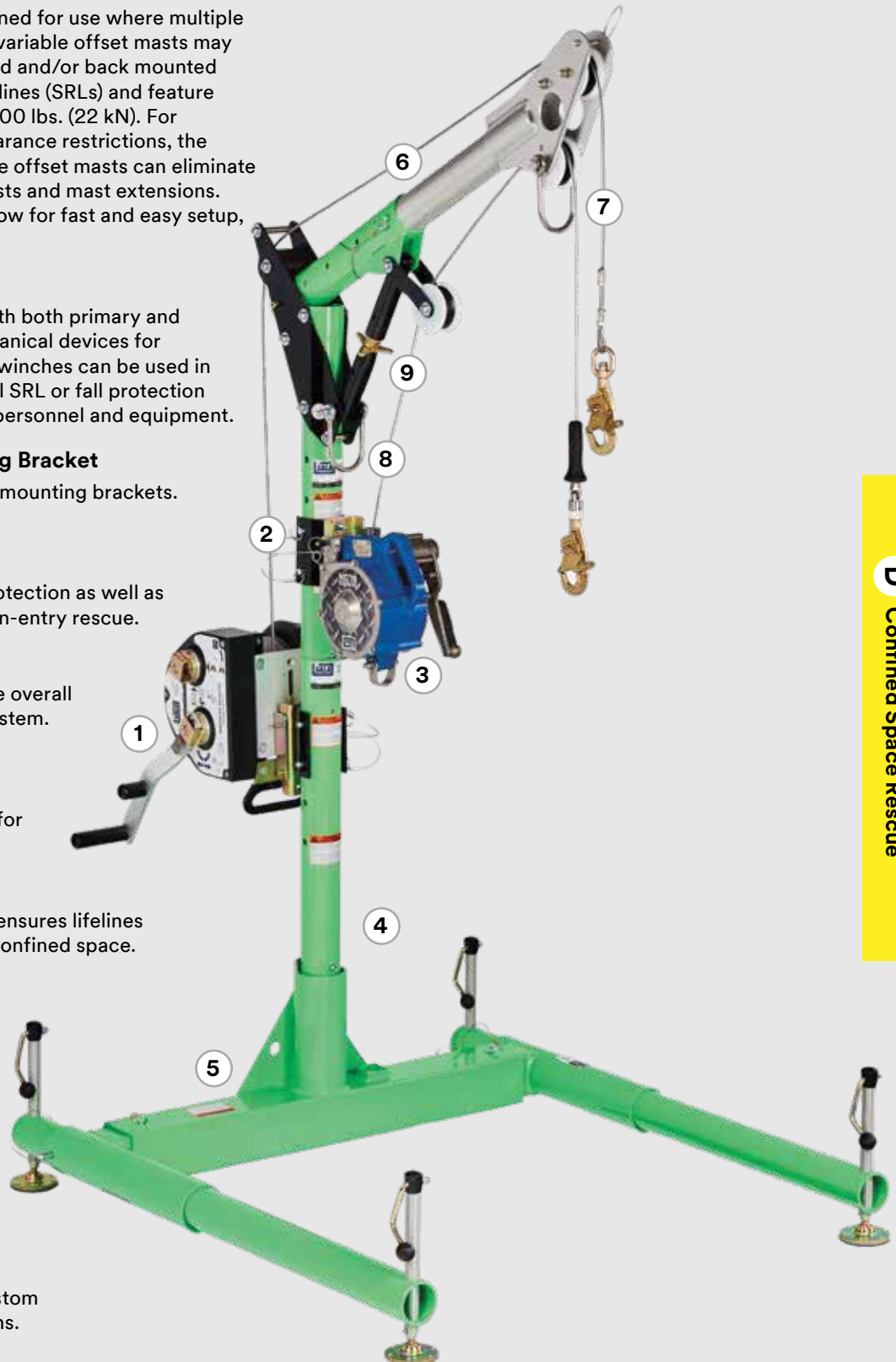

3M™ DBI-SALA® Hoist Systems

8518000

5-Piece Hoist System

Davit arm and base system includes 11.5 in.–27.5 in. (29.2 cm–69.8 cm) Adjustable Offset Upper Mast (8518001), 33 in. (83.8 cm) Lightweight Lower Mast (8518002), and 3-Piece Lightweight Base (8518005). Includes winch mounting bracket. Order winch and Self-Retracting Lifeline separately. Weight: 100 lbs. (45.5 kg)

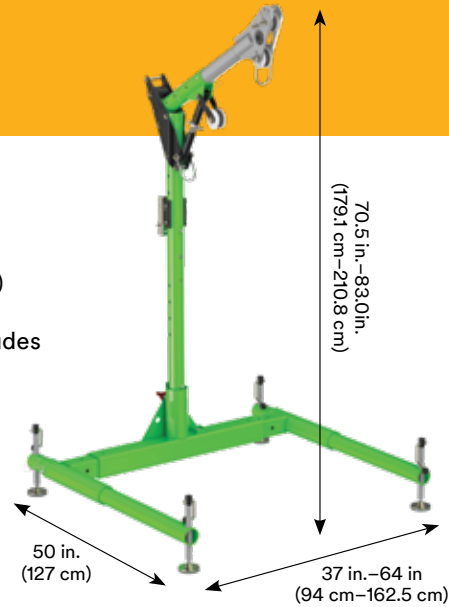

	Short Reach 5-Piece Davit System	Digital Winch	Salalift™ II Winch	Ultra-Lok™ Retrieval SRL	Sealed-Blok™ Retrieval SRL	Davit Carrying Bags	Digital Winch Bags	Extra Winch Bracket
8301100	8518000			3501102		8518513		
8301102	8518000	8518558				8518513	8517567	
8301103	8518000		8102001	3501102		8518513		8549915
8301105	8518000	8518558			3400923	8518513	8517567	8549915
8301107				3501102				
8301109		8518558					8517567	
8301110			8102001	3501102				8549915
8301112		8518558			3400923		8517567	8549915
8518000	8518000							



8518270

5-Piece Equipment Cart

Transport the 5-Piece System with ease over smooth or rough terrain. Ideal for tight storage situations.

8518513 Set of two carrying bags for 5-Piece Hoist System (8518000)

3M™ DBI-SALA®

One-Piece Adjustable Offset Davit Masts

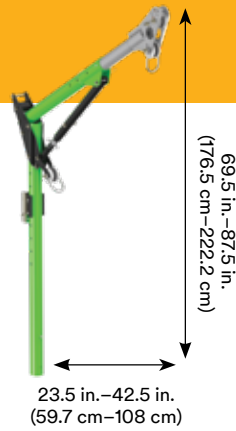

Adjustable offset davit mast	66 in.–76 in. (167.6 cm–193 cm)	78 in.–88 in. (198.1 cm–223.5 cm)	90 in.–100 in. (228.6 cm–254 cm)	69.5 in.–87.5 in. (176.5 cm–222.2 cm)	81.5 in.–91.5 in. (207 cm–232.4 cm)	93.5 in.–111.5 in. (237.5 cm–282.2 cm)
11.5 in.–27.5 in. (29.2 cm–69.8 cm)	8518382	8518383	8518384	–	–	–
23.5 in.–42.5 in. (59.7 cm–108 cm)	–	–	–	8518385	8518386	8518387

Offset Davit Masts & Lower Mast Extensions

Customize the height of these davit masts with up to two Lower Mast Extensions. Custom lengths are available—call us for details.

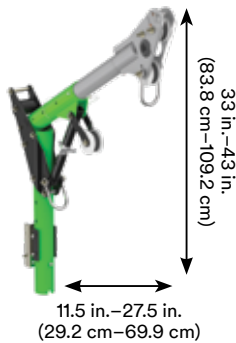

8518001

11.5 in.–27.5 in. Adjustable Offset Davit Mast

(Includes winch mount bracket.) Combine with up to two lower mast extensions to increase anchorage height. Combined extension length cannot exceed 90 in. (228 cm).



8518006

23.5 in.–42.5 in. Adjustable Offset Davit Mast

(Includes winch mount bracket.) Combine with up to two lower mast extensions to increase anchorage height. Combined extension length cannot exceed 78 in. (198 cm).

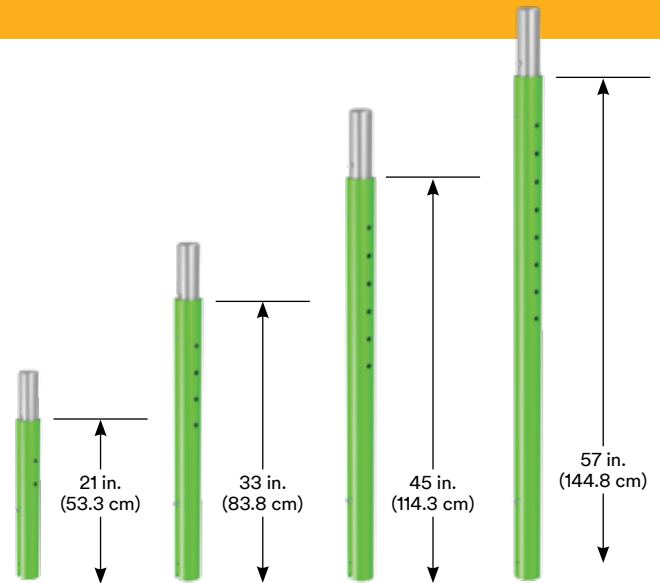

8518509 8518002 8518003 8518004

8518509 21 in. (53.3 cm) Lower Mast Extension.

8518002 33 in. (83.8 cm) Lower Mast Extension.

8518003 45 in. (114.3 cm) Lower Mast Extension.

8518004 57 in. (144.8 cm) Lower Mast Extension.

8513330

Carrying Bag

Carrying bag with protective plastic liner for one piece davit arm (8518382–8518387) and 10 ft. aluminum tripod (8513159).

8513564 Bag with protective plastic liner for Adjustable Offset Davit Mast, with Lower Mast Extension.



D Confined Space Rescue

3M™ DBI-SALA® Fixed Bases

Fixed bases allow for easier setup and teardown, making them ideal for work areas where a base can be permanently installed to an existing structure. All bases come with PVC sleeve liners.

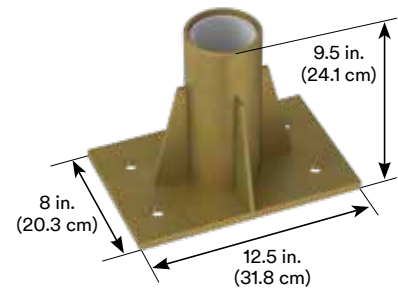

8512831

Center Mount Sleeve
Zinc-Plated

Zinc-plated mild steel construction. Mounts to concrete or steel structure.

Weight: 13 lbs. (5.9 kg)

8516563 304 Stainless steel construction. Mounts to concrete or steel structure.

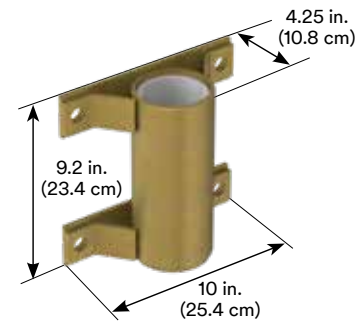

8518348

Wall Mount Sleeve 304
Stainless Steel

304 stainless steel construction. Compact design mounts to vertical concrete or steel structures.

Weight: 12 lbs. (5.5 kg)

8516191 Wall Mount Sleeve, zinc-plated mild steel construction.

3M™ DBI-SALA® Fixed Bases

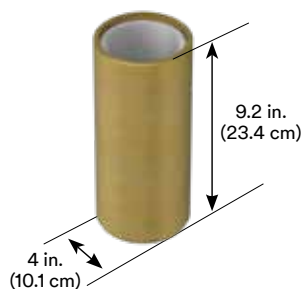

8510109

Core Mount Sleeve

Zinc-plated mild steel construction. Designed for slip-in installation into 4 in. (10.1 cm) core hole in concrete or in an existing steel structure. Weight: 8 lbs. (3.6 kg)

8510110 Core Mount Sleeve, stainless steel construction.

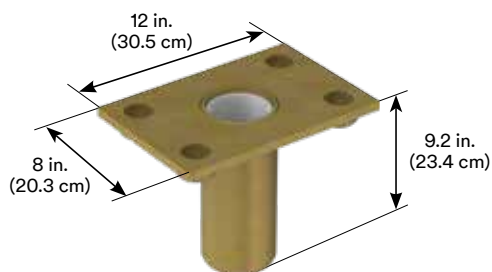

8510316

Floor Mount Sleeve

Mild steel construction. Recessed fastener pockets allow for bolt-in installation into existing concrete or steel structure. Flush mount design eliminates trip hazards when not in use. Weight: 21 lbs. (9.5 kg)

8512827 Flush Floor Mount Sleeve, stainless steel construction.

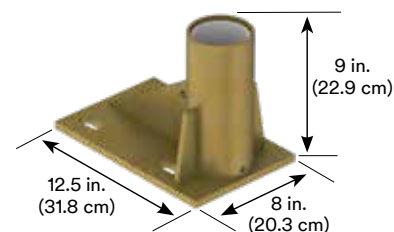

8510057

Offset Floor Mount Sleeve

Zinc-plated mild steel construction. Mounts to horizontal concrete or steel structure. Offset design allows for maximum reach of the mast being used. Weight: 25 lbs. (11.3 kg)

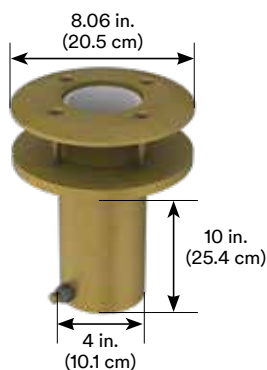

8515162

Deck Mount Sleeve

Zinc-plated mild steel construction. Designed to slip into a 4 in. (10.1 cm) hole in existing flooring. Flush mount design eliminates trip hazards when not in use. Comes with plastic stopper and mounting hardware—mounts to thicknesses from 1/4 in.–2 in. (6.4 mm–50.8 mm). Weight: 17 lbs. (7.7 kg)

8515834 Deck Mount Sleeve, stainless steel construction.

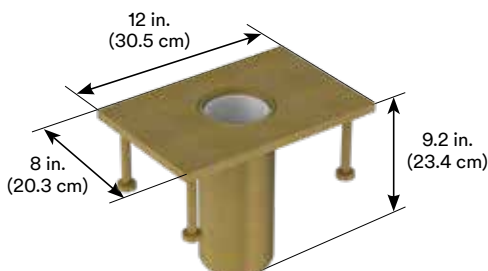

8510311

Flush Floor Mount Sleeve

Mild steel construction. Comes with pins for fresh concrete anchors for new construction or renovation. Flush mount design eliminates trip hazards when not in use. Weight: 21 lbs. (9.5 kg)

8512828 Flush Floor Mount Sleeve, stainless steel construction.

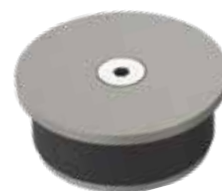

8510827

Heavy-Duty Sleeve Cap

Stainless steel construction. Used with permanent mounted sleeves when installed in high traffic or other severe service locations. Weight: 1.2 lbs. (0.54 kg)

8510826 Heavy-Duty Sleeve Cap, zinc-plated mild steel construction.

3M™ DBI-SALA® Portable Bases

Portable Bases work with a variety of Davit Arm and Mast Extensions. They're ideal when you need to move and access various confined space areas. Bases are lightweight, easy to transport, set up and use.

8518005

3-Piece Portable Base

Adjustable base for 27.5 in. (69.8 cm) maximum offset davit mast.

8518008 3-Piece Portable Base.
Adjustable base for 42.5 in. (108 cm) maximum offset davit mast.

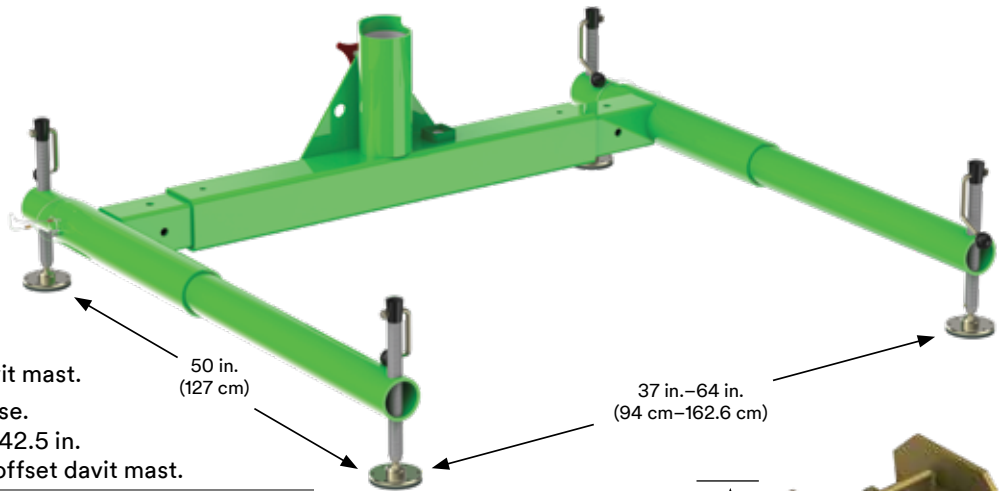

8513565

Carrying Bag

Bag with protective plastic liner for 3-Piece Davit Base (8518005).

8510323

Barrel Mount Sleeve with 3.5 in. Opening

Zinc-plated mild steel construction. Eight independent clamping screws allow temporary installations over edges of shoring cans, walls and other structures. Comes with PVC inner liner. Custom fit openings available.

8510429 Barrel Mount Sleeve with 3.5 in. (76.2 mm) opening, stainless steel.

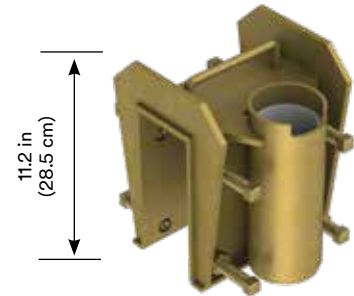

8510568

Forklift Basket

Designed to convert your forklift into a versatile confined space and fall arrest work platform. Add a davit mast and winch/ Self-Retracting Lifeline to the basket and you're ready to go.

Lightweight aluminum construction and tool-free assembly simplifies setup, transport and storage. Durable powder coated finish with anti-slip finish on walking surfaces. Includes spring-loaded gate. Weight: 215 lbs. (98 kg)

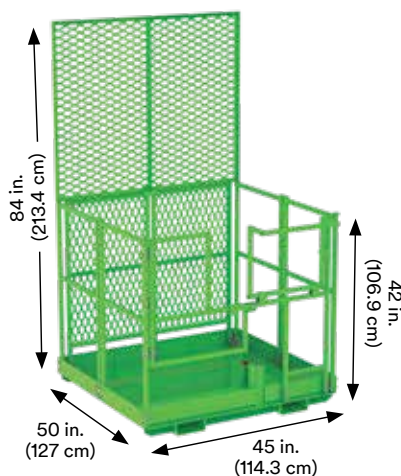

8512285

Adjustable Barrel Mount Sleeve

Designed for shoring, wall and parapet applications. Standard unit accommodates wall thicknesses up to a maximum of 24 in. (60.9 cm), with shorter or longer adjustment tubes available on request. Anodized, welded aluminum with zinc-plated steel hardware with inner sleeve.

8510715 Adjustable Barrel Mount Sleeve for 0 in.–12 in. opening.

8516088 Adjustable Barrel Mount Sleeve for 42 in. maximum opening.

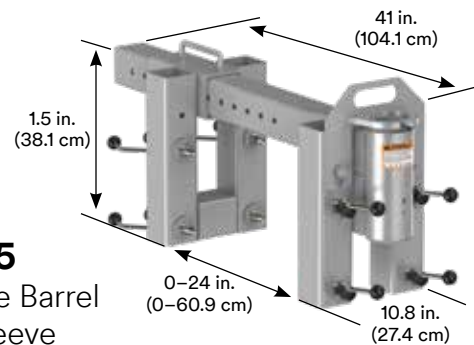

3M™ DBI-SALA® Portable Bases

8510501

3M™ DBI-SALA® Manhole Collars

17.5 in. (44.5 cm) Manhole Collar, fits 18 in.–20 in. (45.7 cm–50.8 cm) diameter. Provides a Portable Davit Base by simply fitting within manhole opening. Powder coated aluminum construction with PVC sleeve liner.

8510520 19.5 in. (49.5 cm) Manhole Collar fits 20 in.–22 in. (50.8 cm–55.8 cm) diameter.

8510457 21.5 in. (54.6 cm) Manhole Collar fits 22 in.–24 in. (55.8 cm–60.9 cm) diameter.

8510163 23.5 in. (59.7 cm) Manhole Collar fits 24 in.–26 in. (60.9 cm–66 cm) diameter.

8510633 25.5 in. (64.7 cm) Manhole Collar fits 26 in.–28 in. (66 cm–71.1 cm) diameter.

8510632 27.5 in. (69.8 cm) Manhole Collar fits 28 in.–30 in. (71.1 cm–76.2 cm) diameter.

8510546 29.5 in. (74.9 cm) Manhole Collar fits 30 in.–32 in. (76.2 cm–81.2 cm) diameter.

8530312 31.5 in. (80 cm) Manhole Collar fits 32 in.–34 in. (81.3 cm–86.4 cm) diameter.

8512994 33.5 in. (83.1 cm) Manhole Collar fits 34 in.–36 in. (86.3 cm–91.4 cm) diameter.



For small davit arms only

8510140

Vehicle Hitch Mount Sleeve

Designed to install into a 2 in. (51 mm) hitch receiver on an attendant vehicle to provide a portable anchor point for confined space entry, rescue and fall arrest systems. Assembly for a maximum 27.5 in. (69.8 cm) Offset Davit Mast.

8514461 Assembly for a maximum 42.5 in. (108 cm) Offset Davit Mast.

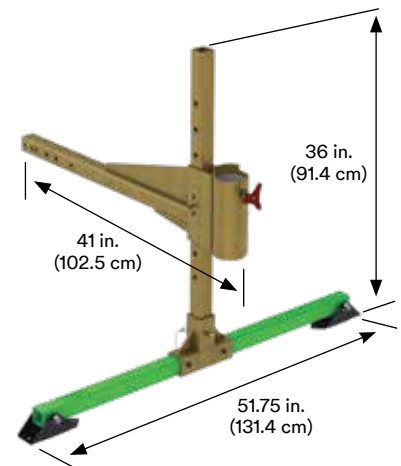

Vehicle Hitch Sleeve Extensions

A maximum of one extension can be used with a hitch mount and a bumper attachment.

8514503 2 ft. (0.61 m) Vehicle hitch mount sleeve extension. Weight: 17 lbs. (7.7 kg)

8512829 4 ft. (1.21 m) Vehicle hitch mount sleeve extension. Weight: 27.8 lbs. (12.6 kg)

8511384 6 ft. (1.83 m) Vehicle hitch mount sleeve extension. Weight: 39 lbs. (17.6 kg)

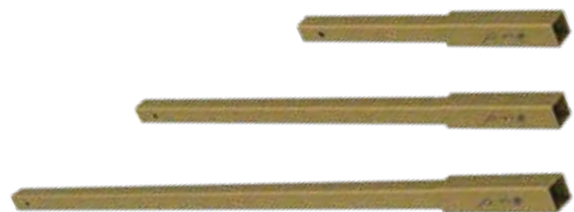

8511401

Universal Joint Assembly

Installs between the Hitch Mount Sleeve (8510140) or extension and the vehicle to compensate for uneven ground conditions. Weight: 10 lbs. (4.5 kg)



3M™ DBI-SALA® Counterweight Systems

Counterweight Systems are composed of a central base unit to accommodate a variety of anchoring options, positioning and adjustment legs, and extension assemblies.

8512894

Counterweight System

Counterweight system base with pole leg assembly.

Weight: 199 lbs. (90.2 kg)

Counterweight requirements determined by application.

Contact customer service to order.

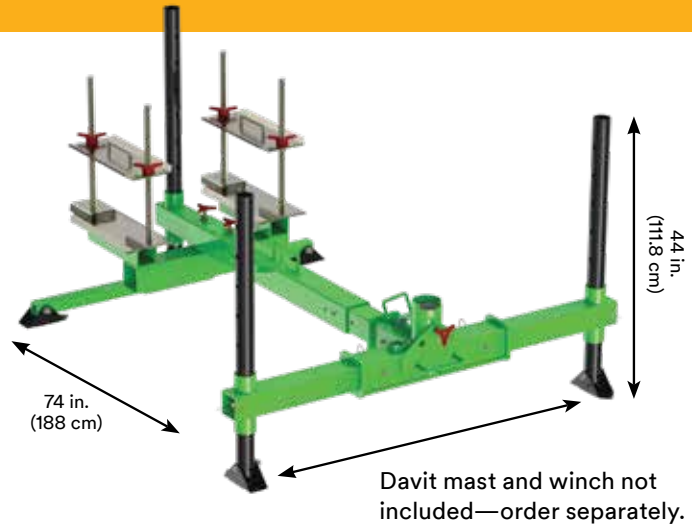

8520775

Mobile Counterweighted Cart Base

Ideal for areas that require access near a leading edge or into large tanks. System comes complete with counterweight cart, 36 in. (91.4 cm) inner extension tube, center section, and two outrigger screw assemblies. System counterweighted by 50 lb. (22.7 kg) weight plates. (Weight plates, davit mast and winch not included—order separately.)

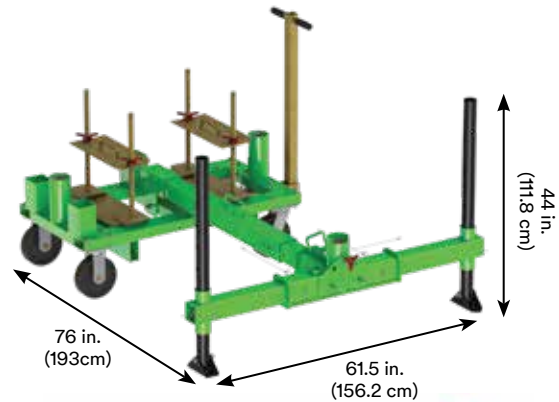

8530088

Portable Catwalk Clamping Base

Designed to secure to 36 in. (91.4 cm) wide walkways. Ideal for areas that require access off a mezzanine or walkway. System comes complete with catwalk hook, 16 in. (40.6 cm) inner extension tube, center section and two outrigger screw assemblies. Other models available to accommodate different widths of walkways. (Davit mast and winch not included—order separately. More options available.)



8530256

Portable Anchor Point Base

Ideal for areas that require access over a leading edge. System comes complete with U-bolt anchor point to attach to secondary fixed anchor, 36 in. (91.4 cm) inner extension tube, center section, and two outrigger screw assemblies. System requires a 5,000 lb. (22 kN) anchorage point to be tied down to. (Davit mast and winch not included—order separately.)



3M™ DBI-SALA® Tripods

Constructed of lightweight tubular aluminum with a rugged steel head assembly. Quick-release pins positively locate components at all adjustment points for tool-free setup and adjustment.

- 1 Mechanical Devices**
Supports up to three winches or SRLs for complete flexibility.
- 2 Quick-Connect Bracket**
Fast and easy attachment of mechanical devices.
- 3 Safety Chain**
Added support in demanding applications.
- 4 Top Mounted Pulley System**
Mount up to three pulleys to route mechanical device lifelines.
- 5 Secondary Anchor Point**
5,000 lb. (22 kN) anchor point for secondary fall arrest system.
- 6 Aluminum Construction**
Lightweight and durable for ease-of-use.

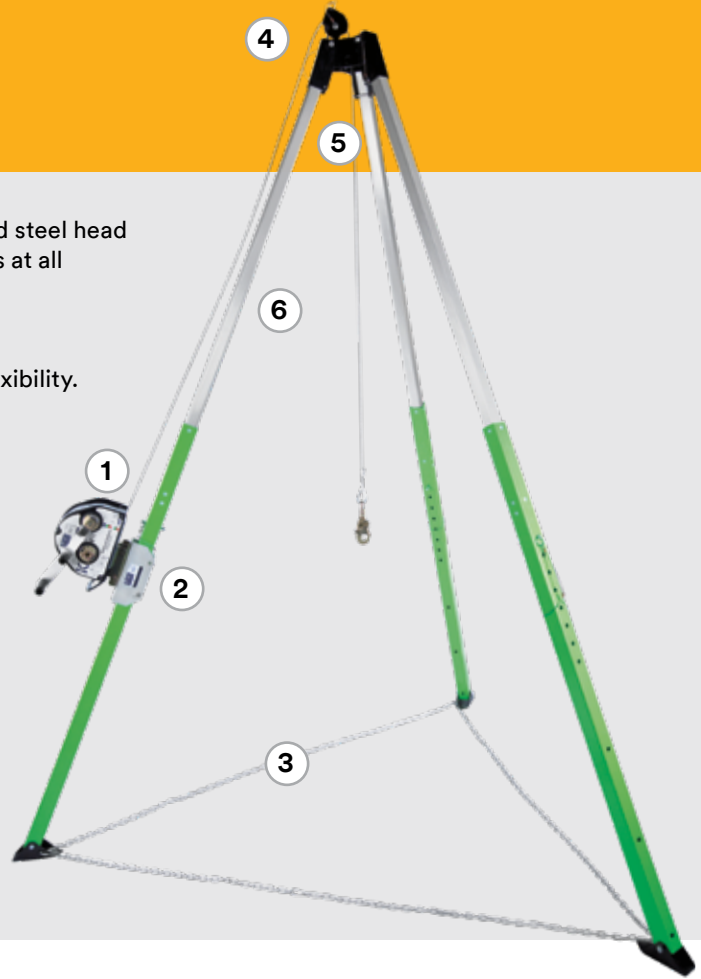

8000000

3M™ DBI-SALA® 7 ft. Aluminum Tripod

- Lightweight, durable aluminum construction.
- Telescoping adjustable locking legs.
- Built-in pulley system.
- 5,000 lb. (22 kN) built-in head mounted anchor point.
- Capacity: 350 lbs. (159 kg)

8000010 9 ft. Tripod

Winch and SRL not included—order separately.



8513158

3M™ DBI-SALA® UCT-300 7 ft. Tripod

- Lightweight, durable aluminum construction.
- Telescoping adjustable locking legs.
- Built-in pulley system—can accommodate up to three pulleys.
- 5,000 lb. (22 kN) built-in head mounted anchor point.
- Capacity: 450 lbs. (204 kg)

8513159 10 ft. (3 m) Tripod

Winch and SRL not included—order separately.



8512292

Winch/SRL Mounting Bracket for Tripod (8513159)

8510224 Winch/SRL Mounting Bracket for Tripod (8513158)



8512293

Top Pulley Assembly for UCT Series Tripods

Routes mechanical device's lifeline over and into confined space area.



8513330

Carrying Bag

For 10 ft. (3 m) Tripod with protective plastic liner (8513159).

8513329 For 7 ft. (2.1 m) tripod with protective plastic liner (8513158)

9503094 For 7 ft. (2.1 m) tripod (8000000)

9503095 For 9 ft. (2.7 m) tripod (8000010)



3M™ DBI-SALA® Tripods

Complete Tripod Solutions



	7' Alum. Tripod	9' Alum. Tripod	Lifeline Type	Salalift™ II Winch	Sealed-Blok™ Retrieval SRL	Ultra-Lok™ Retrieval SRL	Tripod Carrying Bag	Winch/ SRL Mounting Bracket	Leg Mount Pulley
8300030	8000000		Galvanized	60 ft. (18.3 m)					
8300032	8000000		Galvanized	90 ft. (27.4 m)					
8300034	8000000		Galvanized	120 ft. (36.6 m)					
8301030	8000000		Galvanized		50 ft. (15.2 m)				
8301041	8000000		Galvanized	60 ft. (18.3 m)	50 ft. (15.2 m)			8005048	8003238
8301062	8000000		Galvanized			50 ft. (15.2 m)	9503094		
8301066	8000000		Galvanized	60 ft. (18.3 m)		50 ft. (15.2 m)	9503094	8005048	8003238
8300040		8000010	Galvanized	60 ft. (18.3 m)					
8301035		8000010	Galvanized		50 ft. (15.2 m)				
8301049		8000010	Galvanized		85 ft. (25.9 m)				
8301043		8000010	Galvanized	60 ft. (18.3 m)	50 ft. (15.2 m)			8005048	8003238
8301064		8000010	Galvanized			50 ft. (15.2 m)	9503094		
8301068		8000010	Galvanized	60 ft. (18.3 m)		50 ft. (15.2 m)	9503094	8005048	8003238
8300031	8000000		Stainless Steel	60 ft. (18.3 m)					
8300033	8000000		Stainless Steel	90 ft. (27.4 m)					
8300035	8000000		Stainless Steel	120 ft. (36.6 m)					
8301031	8000000		Stainless Steel		50 ft. (15.2 m)				
8301042	8000000		Stainless Steel	60 ft. (18.3 m)	50 ft. (15.2 m)			8005048	8003238
8301063	8000000		Stainless Steel			50 ft. (15.2 m)	9503094		
8301067	8000000		Stainless Steel	60 ft. (18.3 m)		50 ft. (15.2 m)	9503094	8005048	8003238
8300041		8000010	Stainless Steel	60 ft. (18.3 m)					
8301036		8000010	Stainless Steel		50 ft. (15.2 m)				
8301037		8000010	Stainless Steel		85 ft. (25.9 m)				
8301044		8000010	Stainless Steel	60 ft. (18.3 m)	50 ft. (15.2 m)			8005048	8003238
8301069		8000010	Stainless Steel	60 ft. (18.3 m)		50 ft. (15.2 m)	9503094	8005048	8003238

3M™ DBI-SALA® Pole Hoist System

The pole hoist attaches with a carabiner on the universal bracket to a suitable anchor point. It has a unique swivel head that rotates 360 degrees, providing flexibility in both vertical and horizontal confined space entries.



8530252

Extendable Pole Hoist
4 ft.–7 ft. (1.2 m–2.1 m)
Weight: 12 lbs. (5.4 kg)

Extension with swivel head and winch mounting bracket, T-bar leg assembly and hardware/fasteners.

8530253 Extendable Pole Hoist
6 ft.–10 ft. (1.8 m–3 m)
Weight: 14 lbs. (6.4 kg)



8520777

Clamp-On Anchor
for Pole Hoists

Designed to secure to a vertical or horizontal flange up to 6 in. (15.2 cm) thick and provide an anchorage point to connect a pole hoist device to.



2104550

Steel Anchor Plate
with D-Ring

This plate anchor offers a compact, reliable attachment to 3/8 in.–1 in. thick plate steel for connecting your lanyard, vertical lifeline system or self-retracting lifeline.



8513330

Carrying Bag

For 6 ft.–10 ft. pole hoist.

8513329 Carrying Bag for
4 ft.–7 ft. pole hoist.



6320008

Web Sling

6,000 lb. rated, 1 ft. (30.5 cm) long; 3/4 ft (19.1 mm) wide Kevlar® web anchor sling.

3M™ DBI-SALA® Portable Fall Arrest Posts

Our portable fall arrest post allows for up to three workers on top of transformers or other types of vertical platforms with potential fall hazards.

8516693

Rescue Davit Arm for Portable Fall Arrest Post

The optional rescue davit arm assembles to our portable fall arrest post, providing rescue and material handling capabilities.

8516691 post not included—order separately.

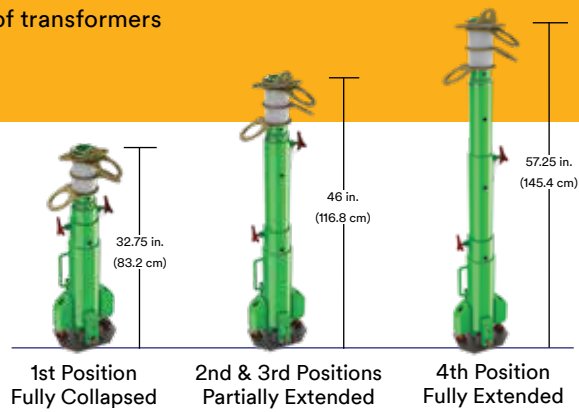
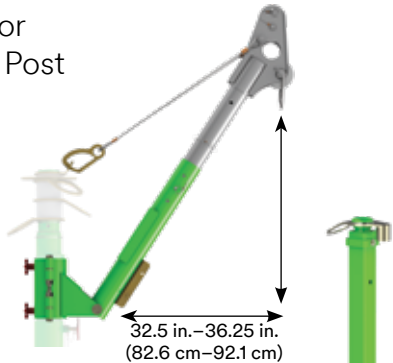

8516691

Portable Fall Arrest Post

- Three independent swiveling tie-off points.
- 360 degrees of protection for three workers.
- Telescopic design; 32.75 in.–46 in.–57.25 in. (83.2 cm–116.8 cm–145.4 cm)
- Aluminum construction.



8516996

Uni-Anchor Fall Arrest Post

The 14 ft. (4.3 m) uni-anchor fall arrest post mounts using uni-anchor plates and extends up to 14 ft. (4.3 m) to provide a 1-man-rated fall arrest anchor point. Weight: 71 lbs. (32.2 kg)

Anchor Bases for Portable Fall Arrest Post

8517412

Bare Steel Uni-Anchor with Tie-Off Anchors

For closed environments without chemical or moisture exposure.

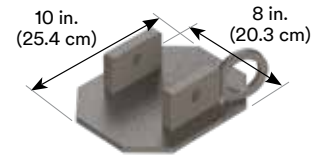

8510816

Weld-On Mounting Plate

Unplated mild steel construction.

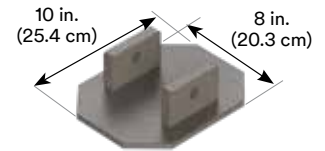

8517413

Incline Adapter with Tie-Off Anchor

Permanently weld to inclined surfaces.

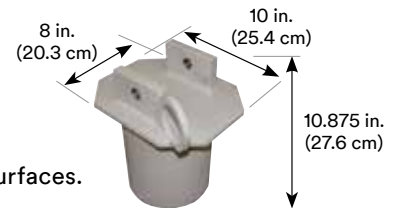

8519819

Base Concrete Anchor

Bolt-on anchor plate for concrete or steel surfaces.

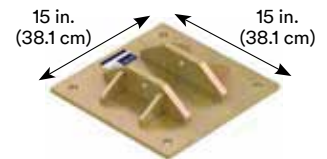

Accessories

8516692

14 in. Anchor Post Extension

Provides option to tie-off one worker at an increased height of 68.5 in. (174 cm). Weight: 5 lbs. (2.2 kg)



8517565

Carrying Bag

Heavy-duty carrying bag for Portable Fall Arrest Post (8516691) or Rescue Davit for Fall Arrest Post (8516693).



3M™ DBI-SALA® Mechanical Systems

Retrieving incapacitated workers and bringing them to safety makes the mechanical device one of the most critical parts of your rescue system. In some situations, you may need a secondary or backup system.

1 Digital Winches

- Man rated 450 lb. (201 kg) capacity.
- Digital usage indicator tracks drum revolutions to determine service intervals.
- Triple redundant braking system.
- Sealed bearings at all contact points.

2 Retrieval Sealed-Blok™ Self-Retracting Lifeline

- Ideal for secondary or backup.
- Man rated 420 lb. (190 kg) capacity.
- Fall arrest system limits forces to 900 lbs. (4 kN)
- Built-in emergency retrieval winch.
- Input handle with primary brake.

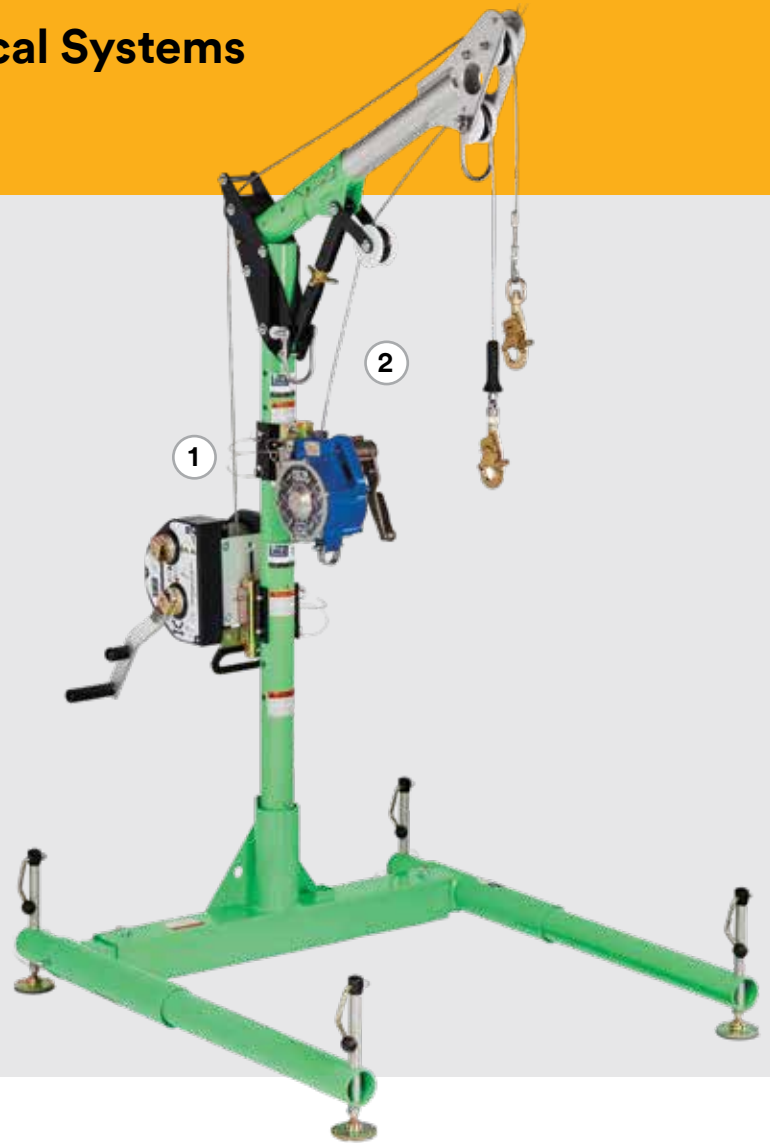

3M™ DBI-SALA® Salalift™ II Winches

- Man rated 350 lb. (159 kg) capacity.
- Overload clutch.
- Gear ratio of 6:1.
- Free-wheel mode.
- Shielded ball bearings.



3M™ DBI-SALA® Winches

Digital Winch

Drive Type	Lifeline Type	Mounting Bracket	60 ft. (18 m)	90 ft. (27 m)	140 ft. (42 m)	190 ft. (58 m)	240 ft. (73 m)	290 ft. (88 m)
Power drive*	Galvanized steel	■	8518567	8518568	8518588	8518589	8518610	8518611
	Stainless steel	■	8518565	8518566	8518586	8518587	8518608	8518609
	Technora® rope	■	8518571					
Removable handle	Galvanized steel	■	8518560	8518561	8518581	8518582	8518603	8518604
	Stainless steel	■	8518558	8518559	8518579	8518580	8518601	8518602
	Technora® rope	■	8518564					
Digital Winch		Cable model weight	30.5 lbs. (13.8 kg)	32.5 lbs. (14.7 kg)	40 lbs. (18.4 kg)	43 lbs. (19.5 kg)	50 lbs. (22.6 kg)	53.5 lbs. (19.5 kg)
			Technora® rope model weight	27 lbs. (12.2 kg)				



Power drive units require Overload Protection Clutch (8512936) — Not Included. Overload Protection Clutch used in conjunction with a drill for retrieving an entrant.

Salalift™ II Winch

Drive Type	Lifeline Type	Mounting Bracket	Winch Bag	50 ft. (15.2 m)	60 ft. (18 m)	90 ft. (27 m)	120 ft. (36.5 m)
Removable handle	Galvanized steel	■	■		8102001	8102009	8102005
	Stainless steel	■	■		8102003	8102011	8102007
	Technora® rope	■	■	8102050			
Salalift™ II Winch			Cable model weight		30.5 lbs. (13.8 kg)	32.5 lbs. (14.7 kg)	38.5 lbs. (17.5 kg)
			Technora® rope model weight	27 lbs. (12.2 kg)			



8549915
Extra Winch Bracket



8512936
Overload Protection Clutch
450 lbs. maximum working load.



8510207
Winch/SRL Adapter with Flat Back
Attaches 3M™ DBI-SALA® Winch/SRL to structures.



8516824
Quick-Release Mounting Bracket
For upper and lower masts.



1001210
Retrieval Wristlets
For upper and lower masts. Ideal for narrow extractions. D-ring at end x 2 ft. (0.6 m).
1001220 Attached with an O-ring at one end x 18 in. (0.46 m).



1231460
Y-Lanyard
Rescue/retrieval design ideal for use with harness incorporating D-rings. D-ring at center x 2 ft. (0.6 m).
1231470 Without spreader bar



8517567
Padded Carrying Bag
For digital winch.

3M™ DBI-SALA® Retrieval Self-Retracting Lifelines

3M™ DBI-SALA® Sealed-Blok™ Self-Retracting Lifelines with Retrieval incorporate a concept that separates all dynamic components, including the motor spring and break, from foreign elements such as grease, moisture and dirt. The sealed design meets IP69K rating.

- Available with RSQ Dual-Mode Design—allows users to select either standard fall arrest mode or automatic descent mode.
- Available lengths ranging from 30 ft. (9.1 m) to 175 ft. (53.3 m).
- IP69K Sealed Rating.



Retrieval Sealed-Blok™ SRL



Retrieval Sealed-Blok™ SRL - RSQ

3M™ DBI-SALA® Ultra-Lok™ Self-Retracting Lifelines with Retrieval are engineered devices you can count on for safety, efficiency and comfort.

- Available in 50 ft. length.



Retrieval Ultra-Lok™ SRL

3M™ DBI-SALA® Sealed-Blok™ vs 3M™ DBI-SALA® Ultra-Lok™

	Maximum Capacity	Maximum Lifeline Length	Lifeline Type			RSQ Available
			Technora® rope	Galvanized	Stainless steel	
Sealed-Blok™	420 lbs. (190.5 kg)	175 ft. (53.3 m)	■	■	■	■
Ultra-Lok™	310 lbs. (140.6 kg)	50 ft. (15.2 m)		■	■	

3M™ DBI-SALA® Retrieval Self-Retracting Lifelines

Cable Type	Sealed-Blok™	Sealed-Blok™ Without Bracket	Sealed-Blok™/ RSQ Without Bracket	Ultra-Lok™	30 ft. (9.1 m)	50 ft. (15.2 m)	55 ft. (16.8 m)	85 ft. (25.9 m)	130 ft. (39.6 m)	175 ft. (52.5m)
Galvanized steel	■				3400853	3400923		3400871	3400976	
		■			3400850	3400920		3400870	3400975	3400660
			■			3400940		3400910		
				■		3501102				
Stainless steel	■				3400858	3400926		3400882	3400987	
		■			3400852			3400874	3400979	3400661
			■			3400942		3400912		
				■		3501103				
Technora® rope	■				3400840		3400843			



3401025

Mounting Bracket for Sealed-Blok™ Retrieval SRL

Fits most sizes of Sealed-Blok™ Retrieval SRL.

3M™ DBI-SALA® Self-Rescue Device

Work at height without worrying about hanging in your harness for an extended period of time after an arrested fall event. Instead of waiting for help, lower yourself to safety with the 3M™ DBI-SALA® Self-Rescue Device.

- 1 Easily Accessible Primary Release Cord**
- 2 Easy-Link SRL Adapter**
A connection point for your lanyards or personal SRLs.
- 3 Molded Padding**
Protects the bag from wear and tear.
- 4 Color-Coded and Reflective Elements**
Provides greater visibility.
- 5 Assisted-Rescue and 3M™ DBI-SALA® Rescue Pole**
Allows for remote access and deployment by a colleague.
- 6 50- and 100-Foot Lengths**
More flexibility and freedom to work at height.
- 7 30 Foot Training Version**
(See next page).



Virtually Universal Attachment

The Self-Rescue Device retrofits to virtually any safety harness.

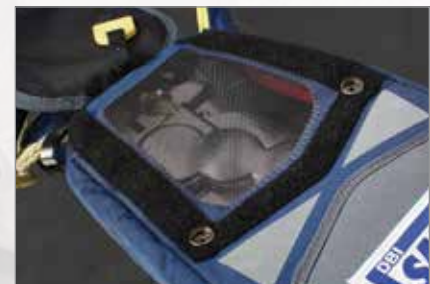

Sealed Descent Device and Rope Spool

3M™ DBI-SALA® Self-Rescue Device



3320031

Self-Rescue 100

Height: 19 in., Width: 7 in.
Depth: 2.5 in., 100 ft. of 5.5 mm rope.

3320030

Self-Rescue 50

Height: 19 in., Width: 7 in.
Depth: 2.5 in., 50 ft. of 5.5 mm rope.

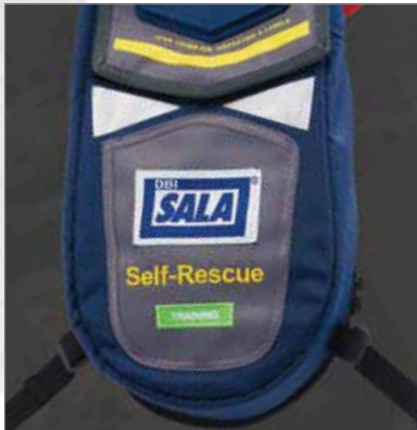

3320037

Self-Rescue Training Device

This 30-foot trainer device simulates a realistic fall rescue experience, allowing you to educate your team on the use of the product. It's easy to rewind the rope on-site, so you can train your team up to 20 times before recertification of the device will be required.

Height: 19 in., Width: 7 in.
Depth: 2.5 in., 30 ft. of 5.5 mm rope.



8900299

Rescue Pole

Kit includes bag, rescue pole, carabiner and tagline.

Bag length: 28.5 in.
Width: 6 in.
Depth: 2 in.
Weight: 2 lbs.
Pole extends to 8 ft. 8 in.



3M™ DBI-SALA® Dual-Mode Descent

Work and rescue with the same equipment with the built-in rescue operation of our dual-mode descent technology.



Fall arrest mode

A speed-sensing brake stops the fall, reduces forces imposed on the user to safe levels, and allows for assisted rescue via hand, by pole, or a traditional assisted rescue operation.



Automatic descent mode

A speed-sensing brake stops the fall, and a centrifugal brake instantly activates to lower the user at a controlled speed to the next level or ground.



Sealed-Blok™ RSQ Self-Retracting Lifelines

Stainless steel wire rope with swivel snap hook, RSQ dual-mode, anchorage carabiner, 4 ft. (1.2 m) cable tie-off adapter.

3400932 50 ft. (15.23 m)

3400886 85 ft. (25.5 m)

3400991 130 ft. (39 m)

Also available with galvanized cable and snap hook, please contact 3M Fall Protection.



Ultra-Lok™ RSQ Self-Retracting Lifelines

50 ft. (15.2 m) of 3/16 in. (5 mm) wire rope with swivel snap hook and RSQ dual-mode.

3504550 Galvanized Steel
Wire Rope

3504552 Stainless Steel
Wire Rope

3M™ DBI-SALA® Rollgliss™ R550 Rescue and Descent

1 Drill Adapter
Provides a mechanical option to raise a victim.

2 Cast Aluminum Housing

3 Bi-Directional Hub
Brings one hook up as the other goes down, for immediate use after each descent.

4 Anchorage

5 Integrated Rope Ears
Greater descent speed control in assisted rescues.

6 Dual Brakes
Added security, safety and peace of mind.

7 Durable Rope
3/8 in. (9.5 mm) Static Kernmantle Rope.

8 Lifeline Hook
Patented Self-Locking Snap Hook.



Drill adapter

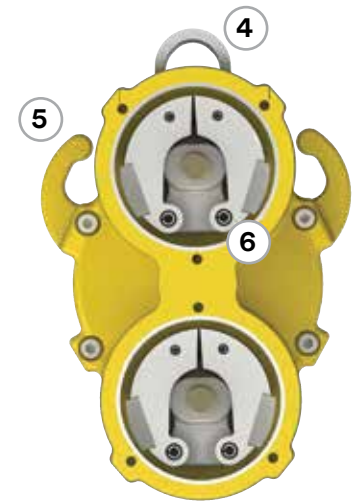

Multiple Length Options

Lengths between 50 ft. (15 m) and 500 ft. (152 m)

Two-Person Capacity

Can be used from heights up to 1,640 ft. (500 m) for one user at 310 lbs. (141 kg) or 575 ft. (175 m) for two users totaling 620 lbs. (282 kg)

Optional Ladder Bracket

Sold separately—3320014.

3M™ DBI-SALA® Rollgliss™

R550 Rescue Units

Includes carabiner (two), 4 ft. (1.22 m) anchor sling and rope bag.

Selection guide:

Part #	Length
3327050	50 ft. (16 m)
3327100	100 ft. (31 m)
3327150	150 ft. (46 m)
3327200	200 ft. (61 m)
3327275	275 ft. (84 m)
3327300	300 ft. (92 m)
3327325	325 ft. (100 m)
3327350	350 ft. (107 m)
3327400	400 ft. (122 m)
3327450	450 ft. (137 m)
3327500	500 ft. (153 m)



3M™ DBI-SALA® Rollgliss™

R550 Escape Units

Includes carabiner (two), 4 ft. (1.22 m) anchor sling.

Selection guide:

Part #	Length
3325100	100 ft. (31 m)
3325200	200 ft. (61 m)
3325300	300 ft. (92 m)
3325400	400 ft. (122 m)
3325500	500 ft. (152 m)



3M™ DBI-SALA® Rollgliss™

R550 Rescue Units with Case

Includes edge protector, 4 ft. (1.22 m) anchor sling (two), 2.5 ft. (0.76 m) anchor sling, pulley, rope grab, carabiner (three), rope bag and humidity case.

Selection guide:

Part #	Length
3326100	100 ft. (31 m)
3326300	300 ft. (92 m)
3326350	350 ft. (107 m)



9508289

9506162

Rope Bag



3620005

Anchoring Sling

4 ft. (1.22 m)



3620004

Anchoring Sling

2.5 ft. (0.76 m)



3320003

Edge Protector with Carabiner



9504733

Pulley



8900298

Rescue Pole



8900293

Rescue Pole Hook for Hot Stick



3320014

Ladder Bracket



9508289

Humidity Case

Fully sealed case provides 10 year minimum storage life. External humidity indicator allows user to inspect the seal without opening case.



2000112

Carabiner

11/16 in. (1.75 cm) gate.



2000041

Carabiner

2-1/8 in. (5.38 cm) gate.



3M™ DBI-SALA® Rollgliss™ R350 Rescue and Descent Positioning Device

8902004

Rollgliss™ R350
Rescue System

50 ft. travel/200 ft. of
3/8 in. rope (15.2 m/61 m),
3:1 ratio with pulleys, rope
control device, anchor
strap, carabiner and
carrying bag.

8902006

Rollgliss™ R350
Rescue System

100 ft. travel/400 ft.
of 3/8 in. rope (30.5 m/
122 m), 3:1 ratio with
pulleys, rope control
device, anchor strap,
carabiner and carrying bag.

*Other lengths available in 10 ft.
(3 m) increments. Accessories
including 2:1, 4:1 and 5:1 pulleys
are available.*



Rollgliss™ Rescue Positioning Device

Service buildings, bridges and dams with this versatile rescue positioning device. It features a speed-sensing lock that allows you to manually lock off the device once you reach a work level. It serves both as a rescue system and has features for raising, lowering and positioning during normal work activities.

- Pre-rigged for quick and easy installation and use.
- No special tools, power source or extensive skills needed.
- Built-in brake.
- Lock-out mechanism allows user to stop/start anywhere.

3602050

Rollgliss™ Rescue Positioning Device

50 ft. travel/260 ft. of 3/8 in. rope (15.25 m/79.3 m),
4:1 ratio with pulleys, rope anchor straps, two carabiners
and carrying bag.

3602100 100 ft. travel/510 ft. (30.5 m/155.5 m)

3M™ DBI-SALA® Rollgliss™ Descender

Make a quick and safe escape. Either vertical or sloped descent models are available to provide complete versatility and flexibility for any job site or work environment.



3303000

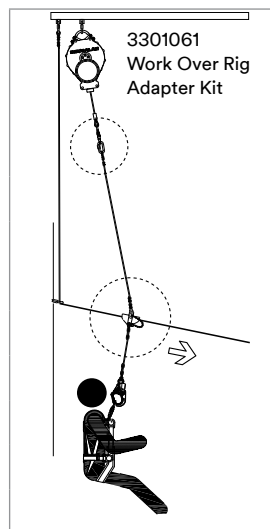

Descent type	Lifeline material	Low or high speed	115 ft. (35 m)	200 ft. (61 m)
Vertical	Galv	Low	3303000	-
		Low	-	3303017
	SS	Low	3303002	-
		Low	-	3303018
Sloped	Galv	Low	3303001	3303021
		High	-	3303015
	SS	Low	3303003	3303019
		High	-	3303016

Sloped low speed models also include linkage, guide cable sleeve and suspension bars. Sloped high speed models include linkage, braking trolley and suspension bars.

3M™ DBI-SALA® Rollgliss™ Systems

8900292

Rollgliss™ R250 Rescue Kit

Enables the rescuer to remove a person from danger without putting themselves at risk by descending to them.

- 33 ft. (10 m) travel length.
- Transported in backpack-style bags.

8900293 Rollgliss™ Rescue Kit with 66 ft. (20 m) travel length.

8900294 Rollgliss™ Rescue Kit with 99 ft. (30 m) travel length.



3601490

Rollgliss™ Sealed Tension Limiter

Attaches to man-riding system in-line between the person and the raising/lowering line to warn operator and limit forces on an entangled worker.

Always use a separate back-up fall protection device with this system.



8516294

Rollgliss™ Rescue Ladder

Provides a way to assist rescue after a fall has occurred. It can be anchored to a structure and dropped to the victim, so they can climb up or down to safety.

- Available in 8 ft. (2.4 m) sections.
- Extra sections can be added.
- Includes three carabiners for attachment.
- For use with Rollgliss™ Rescue Ladder Anchor (8516316).



8516316

Rollgliss™ Rescue Ladder Anchor

For mounting rescue ladder to a davit arm or single anchorage point.

- For use with Rollgliss™ Rescue Ladder (8516294).



Safety training with true value.



Protect your people. Protect your business.

All around the world, we bring expertise to education development, delivery and management. Our training focuses on education, knowledge and principles. No matter your location or industry, application, gear or requirement, you and your workers will benefit from our content and delivery methodologies.

Our vision:

Training that protects people, improves lives and enhances productivity.

Our mission is ensuring every single worker we train receives the critical knowledge and skill development they need for their industry in a way that's relatable and understandable to them.

Our instructors use our structured curriculum—with their individual style—and your situations and environment to create the best overall experience possible.

What's the 3M difference?



There's a broad spectrum of safety training offerings, so it's critical to dig deeper to ensure that you get the quality up-to-date training that you require. Here's what you can expect with 3M Safety Training:

Dedicated Instructors

It's not enough to just know the rules or know the gear. Our instructors have strong technical, industry and teaching backgrounds so they know how to make training knowledge real and relevant to each person they train.

Instructor-Led Courses

Fall protection. Confined spaces. Rescue. Just about anywhere the job takes you, we've got relevant courses that educate on the standards, practical applications and hands-on exercises to make it all "stick" with students.

Certified Instructor Program

For some organizations, it's more sensible to "train a new trainer," so you can invest in a dedicated, trained employee and have the ability to continuously train employees throughout the year on an as-needed basis.

Regulatory Standards Compliance

We don't just follow the rules—some of our team actively advise and contribute to the development of them. Our technical understanding and adherence to all relevant safety standards in every region allows us to help guide and clarify them for you and your team.

World-Class Training Centers, On-Site Delivery, or Virtual Instructor-Led Training

With dedicated training facilities across the U.S. and Canada, to virtual studios that deliver select programs with virtual instructor-led training, as well as on-site instructor-led training capabilities, 3M Safety Training is right where you need it to be.

Broad Employee Appeal

As students of science, we never stop learning—and you shouldn't either. Whether you're upper management, a foreman, supervisor, safety specialist or front line worker, we have training solutions that can teach you valuable insights you won't soon find anywhere else.

Ready for training with true value?

Visit [3M.com/SafetyTraining](https://www.3m.com/SafetyTraining) to learn more.

**Protecting People.
Improving Lives. Enhancing Productivity.**

Six customer value drivers. Each leveraging the 3M Science of Safety.



Industry Experience



Hazard Awareness



Regulatory Knowledge



Innovative Technologies



Quality Products



Education & Training

Aiming for a
zero-drop policy.



Protecting workers takes more than just keeping them from falling.

From construction sites to oil rigs, 3M™ DBI-SALA® Fall Protection for Tools helps work environments stay safe by reducing falling object incidents that can result in personal injury, equipment damage, and tool loss.
ANSI/ISEA 121-2018

Certified and tested.

Our drop prevention solutions are designed with the craft in mind, and are third-party tested in the harshest possible conditions—extreme heat, cold, moisture, corrosion and abrasion. We conduct dynamic and static strength tests, both in the field and in our ISO 9001-certified manufacturing facilities to ensure you get high quality and reliable fall protection for tools.

3M™ DBI-SALA® Attachment Points

D-Rings

- D-rings can be attached to tools under 5 lb (2.3 kg) or 2 lb (0.9 kg) using our Quick-Wrap Tape (see page 47).
- Dual D-rings allow for 100% tool tie-off during tool transfers.



Selection guide:

Part #	Description	Load rating	Quantity	Non-conductive
1500003	D-ring 0.5" x 2.25" (1.3 cm x 5.7 cm)	2 lb (0.9 kg)	10 Pack	No
1500004	D-ring 0.5" x 2.25" (1.3 cm x 5.7 cm)	2 lb (0.9 kg)	100 Pack	No
1500005	D-ring 0.5" x 2.25" (1.3 cm x 5.7 cm) non-conductive	2 lb (0.9 kg)	10 Pack	Yes
1500006	D-ring 0.5" x 2.25" (1.3 cm x 5.7 cm) non-conductive	2 lb (0.9 kg)	100 Pack	No
1500007	D-ring 1" x 3.5" (2.5 cm x 8.9 cm)	5 lb (2.3 kg)	10 Pack	No
1500008	D-ring 1" x 3.5" (2.5 cm x 8.9 cm)	5 lb (2.3 kg)	50 Pack	No
1500001	Dual D-ring small	2 lb (0.9 kg)	10 Pack	No

Quick-Wrap Tape

- 1" (2.5 cm) wide tape conforms to the shape of whatever it is applied to.
- Used with our D-Rings and Tool Cinch Attachments to create tethering points on tools.
- Made from a self-fusing silicone rubber that leaves no adhesive or residue behind.
- Inner fiberglass webbing increases the strength of the tape and makes the tape resistant to sharp objects.

Selection guide:

Part #	Description	Quantity	Length
1500174	Quick wrap, yellow	1	108" (274.3 cm)
1500175	Quick wrap, yellow	10	108" (274.3 cm)
1500168	Quick wrap, blue	1	108" (274.3 cm)
1500169	Quick wrap, blue	10	108" (274.3 cm)
1500171	Quick wrap, blue, 2x length	1	216" (548.6 cm)
1500172	Quick wrap, blue, 2x length	10	216" (548.6 cm)

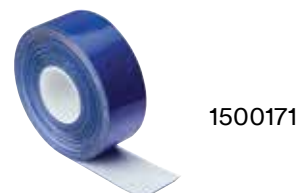
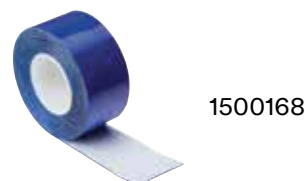

3M™ DBI-SALA® Attachment Points

Tool Cinch Attachments

- Tool Cinch Attachments feature a cinch design that allows users to secure equipment up to 35 lb (15.9 kg) or 80 lb (36.3 kg).
- Stabilization wings can be used to keep Tool Cinch Attachments in place using our Quick-Wrap Tape.

Selection guide:

Part #	Description	Load rating	Stabilization wings
1500015*	V-Ring attachment point, stabilization wing	35 lb (15.9 kg)	2
1500016	V-Ring attachment point, stabilization wing	35 lb (15.9 kg)	2
1500013*	V-Ring attachment point, stabilization wing	35 lb (15.9 kg)	1
1500014	V-Ring attachment point, stabilization wing	35 lb (15.9 kg)	1
1500011*	V-Ring attachment point, stabilization wing	35 lb (15.9 kg)	None
1500012	V-Ring attachment point, stabilization wing	35 lb (15.9 kg)	None
1500017	V-Ring attachment point, stabilization wing	80 lb (36.3 kg)	2
1500018	V-Ring attachment point, stabilization wing	80 lb (36.3 kg)	2

*Patent pending

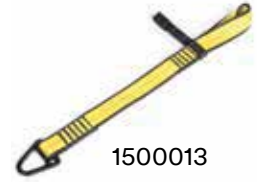

1500013

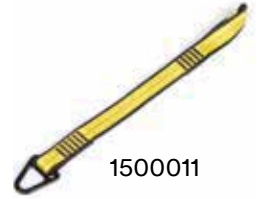

1500011

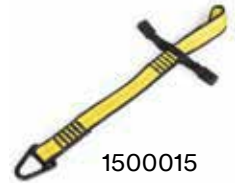

1500015

1500009

D-Ring Cord

- Cinches to tools weighing up to 5 lb (2.3 kg).
- Pass the loop end of a D-Ring Cord through a pre-drilled hole or closed handle to create an attachment point.
- Comes in a pack of 10.



3M™ DBI-SALA® Tethers

Bungee Tethers

Our bungee tethers are third-party load rated and thoughtfully designed to prevent dropped objects.



Part #	Description	Load rating	Length (relaxed)	Length (stretched)
1500047	Hook2Loop Bungee Tether	15 lb (4.5 kg)	32" (81.3 cm)	47" (119.4 cm)
1500048	Hook2Loop Bungee Tether (10 pack)	15 lb (4.5 kg)	32" (81.3 cm)	47" (119.4 cm)
1500049	Medium-Duty Hook2Loop Bungee Tether	35 lb (15.9 kg)	31" (78.7 cm)	52" (132.1 cm)

Coil Tethers

Easy to clean and out of the way—exactly what a tether should be. The lightweight vinyl construction and compact design of our Coil Tethers makes them an ideal alternative to classic bungee tethers.



1500159

Hook2Hook Coil Tether with Swivel

- Compact design stays close to the body
- 5 lb (2.3 kg) load rating

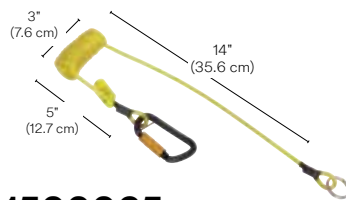

1500065

Hook2QuickRing Coil Tether with Tail

- Use with hammers and other long-handled tools
- Available as a combo with our Hammer Holster
- 2 lb. (0.9 kg) load rating



1500178

Hard Hat Tether

- Simple installation and removal
- Patented clip holds stronger when force is applied to it
- 4 lb. (1.8 kg) load rating

3M™ DBI-SALA® Tool Lanyards



1500050

Medium-Duty Hook2Loop Lanyard

- Features an aluminum double-action twist-lock carabiner to help prevent accidental openings
- Works well with medium-duty tool cinch
- 35 lb (15.9 kg) load rating
- 72" (182.9 cm) length



1500052

Heavy-Duty Hook2Rail Lanyard

- Features an aluminum double-action twist-lock carabiner to help prevent accidental openings
- Large double-action twist-lock rail carabiner
- Works well with heavy-duty tool cinch
- 80 lb (36.3 kg) load rating
- 72" (182.9 cm) length

3M™ DBI-SALA® Single and Dual Tool Holsters



- Single and Dual Tool Holsters are equipped with D-rings that are load rated for 5 lb (2.3 kg).
- Several variants of these holsters come with Retractors (indicated below). Retractors are load rated for 1-1/2 lb (0.7 kg).
- Single and dual tool holsters feature High-Visibility Reflectors and the Magnetic Tool Staging System.
- A bottom drain vent allows the holster to perform even in wet conditions.

Selection guide:

Part #	Description	Retractors included	Attachment
1500104*	Single Tool Holster with Retractor	1x	Harness
1500102*	Single Tool Holster with Retractor	1x	Belt
1500105*	Extra-Deep Single Tool Holster	None	Belt
1500108	Dual Tool Holster	None	Harness
1500109*	Dual Tool Holster with Retractors	2x	Harness
1500106	Dual Tool Holster	None	Belt
1500107*	Dual Tool Holster with Retractors	2x	Belt

*Patent pending

1500098

Tape Measure Holster with Retractor

- Designed to be used with a tape measure, or the optional tape measure sleeve, allowing tape measures to be safely tethered and holstered.
- Includes a Retractor.
- The tape measure sleeve conforms to the size of most tape measures.
- Features High-Visibility Reflectors.

1500099 Tape Measure Sleeve

1500100 Tape Measure Holster with Retractor and Sleeve Combo



3M™ DBI-SALA® Tool Holsters

1500165

Large Tape Measure Sleeve

- Compliment to existing 25' Tape Measure Sleeve.
- Provides a solution for most large tape measures used on a job site.



1500095

Pouch Holster with Retractor

- Quickly holster tape measures and other small tools.
- Includes a Retractor.



Patent pending

1500096

Scaffold Wrench Holster with Retractor

- Quickly holster scaffold wrenches while working at height.
- Features High-Visibility Reflectors.

1500097 Scaffold Wrench Holster with Retractor and Hook2Loop Bungee Tether



Patent pending



Back of holster features pouch for Safety Retractor 1500069. Rear feed system allows retractor to tie off a scaffold wrench while staying out of the way.

1500093

Hammer Holster

- The Hammer Holster allows for the safe holstering of most hammers under 5 lb (2.3 kg).
- D-ring on the side of the holster is load rated for 5 lb (2.3 kg).
- The 1500094 combo comes with a 1500065 Hook2Quick Ring Coil Tether that is specially designed for use with the Hammer Holster. The Hook2Quick Ring Coil Tether is load rated for 2 lb (0.9 kg).
- During transport, the Hammer Holster can be locked shut with a hook and loop strap. While being used, the strap can be locked up allowing for easy hammer access and holstering.

1500094 Hammer Holster & Hook2Quick Ring Coil Tether



Patent pending

Top: Hammer Holster is locked, preventing hammer from slipping out.

Bottom: Hammer Holster is unlocked, making it suitable for active use.

3M™ DBI-SALA® Tool Holsters



1500090

Battery Holster/Sleeve

- Unique sleeve design conforms to the size of most drill batteries.
- Sleeve is cinched to the drill, allowing the drill to be tethered off while being used at height.
- 10 lb. (4.5 kg) load rating.



Can be worn from a belt or harness.

Patent pending



1500088

1500060

1500088

Adjustable Radio Holster

- Holster adjusts to fit most hand-held radios, cell phones, and many other devices.
- Can be worn from belt or harness.
- A Micro D-Ring can be placed on the back of a device, and can then be tethered to a D-ring on the front of the Adjustable Radio Holster using a 1500065 Clip2Loop Coil Tether.

1500089 Adjustable Radio Holster, Clip2Loop Coil Tether and Micro D-Ring

3M™ DBI-SALA® Tool Pouches



1500132

Utility Pouch

- Features two outside pockets for storing spud wrenches and two inner pockets for storing additional tools.
- Tools can be tethered to D-rings on the inside and outside of the pouch.
- Adjustable side-release closure system helps prevent objects from falling out when the pouch isn't being used.

1500130 Utility Pouch with Zipper Closure



1500119

Small Parts Pouches

- Self-closure system traps objects inside, making it nearly impossible for objects to fall out once placed in the bag.
- Easy to retrieve objects since no opening or closing is necessary.
- Compatible with most tool belts; belt loops located on back of pouch.

Part #	Description
1500123	Small Parts Pouch, extra deep canvas black
1500121	Small Parts Pouch, canvas orange
1500120	Small Parts Pouch, canvas camo
1500122	Small Parts Pouch, vinyl yellow
1500119	Small Parts Pouch, canvas black

3M™ DBI-SALA® Safe Buckets

With an integrated closure system that helps prevent dropped objects, these Safe Buckets are designed to be the perfect companion for workers at height carrying heavy loads.

1500134

Standard Safe Bucket

- Built-in connection points.
- Canvas version is load rated for 100 lb (45.4 kg), and vinyl load rated for 250 lb (113.4 kg).
- Integrated carabiner and hoisting strap.
- Durable material helps prevent punctures.



1500134



1500140

Selection guide:

Part #	Load rating	Closure system	Body material	Height/diameter	Capacity
1500134	100 lb (45.4 kg)	Hook and loop	Canvas	15"/12.5" (38 cm/31.75 cm)	1840 in. ³ (4673.6 cm ³)
1500133	100 lb (45.4 kg)	Drawstring	Canvas	15"/12.5" (38 cm/31.75 cm)	1840 in. ³ (4673.6 cm ³)
1500140	250 lb (113.4 kg)	Hook and loop	Vinyl	15"/12.5" (38 cm/31.75 cm)	1840 in. ³ (4673.6 cm ³)
1500139	250 lb (113.4 kg)	Drawstring	Vinyl	15"/12.5" (38 cm/31.75 cm)	1840 in. ³ (4673.6 cm ³)



Closure systems

Every Safe Bucket features either a unique drawstring or a locking hook and loop closure system that acts as an extra layer of spill-protection during transport and lifting. Colourful indicator tabs provide quick visual cues to indicate whether the bucket is in lockdown mode or easy-access mode.



1500141

Hard-Body Safe Bucket Insert

- Converts a standard soft-body Safe Bucket into a hard-body Safe Bucket.
- Our reusable hard-body Safe Bucket insert keeps your Safe Bucket standing upright, making it easier to stage tools and stay productive.
- Integrated inner pockets allow tools to be holstered and organized quickly.

Additional Information

▲WARNING

Compliant fall protection and emergency rescue systems help prevent serious injuries associated with fall events. Users must read and understand the User Instructions provided with the product, and must be properly trained by their employers in the safe use of these systems before using them, per OSHA 1910.140 and 1926.503 or applicable local standards. Misuse or failure to follow warnings and instructions may result in serious personal injury or death. For proper use, see supervisor, User Instructions, or call 800-328-6146 (Opt. 1).

Your nationwide 3M distributor

For questions regarding 3M fall protection products, pricing, and more, please contact:



(844) 958-1187

fallprotect.com

Product Selection and Use: Many factors beyond 3M's control and uniquely within user's knowledge and control can affect the use and performance of a 3M product in a particular application. As a result, customer is solely responsible for evaluating the product and determining whether it is appropriate and suitable for customer's application, including conducting a workplace hazard assessment and reviewing all applicable regulations and standards (e.g., OSHA, ANSI, etc.). Failure to properly evaluate, select, and use a 3M product in accordance with all applicable instructions and with appropriate safety equipment, or to meet all applicable safety regulations, may result in injury, sickness, death, and/or harm to property.

Warranty, Limited Remedy, and Disclaimer: Unless a different warranty is specifically stated on the applicable 3M product packaging or product literature (in which case such warranty governs), 3M warrants that each 3M product meets the applicable 3M product specification at the time 3M ships the product. 3M MAKES NO OTHER WARRANTIES OR CONDITIONS, EXPRESS OR IMPLIED, INCLUDING, BUT NOT LIMITED TO, ANY IMPLIED WARRANTY OR CONDITION OF MERCHANTABILITY, FITNESS FOR A PARTICULAR PURPOSE, OR ARISING OUT OF A COURSE OF DEALING, CUSTOM, OR USAGE OF TRADE. If a 3M product does not conform to this warranty, then the sole and exclusive remedy is, at 3M's option, replacement or repair of the 3M product or refund of the purchase price. Warranty claims must be made within one (1) year from the date of 3M's shipment.

Disclaimer: 3M industrial and occupational products are intended, labeled, and packaged for sale to trained industrial and occupational customers for workplace use. Unless specifically stated otherwise on the applicable product packaging or literature, these products are not intended, labeled, or packaged for sale to or use by consumers (e.g., for home, personal, primary or secondary school, recreational/sporting, or other uses not described in the applicable product packaging or literature), and must be selected and used in compliance with applicable health and safety regulations and standards (e.g., U.S. OSHA, ANSI), as well as all product literature, user instructions, warnings, and limitations, and the user must take any action required under any recall, field action or other product use notice. Misuse of 3M industrial and occupational products may result in injury, sickness, or death. For help with product selection and use, consult your on-site safety professional, industrial hygienist, or other subject matter expert. For additional product information, visit www.3M.com.

3M, DBI-SALA, Cynch-Lok, Delta, Delta Vest, ExoFit, ExoFit NEX, Flexiguard, Force, Lad-Saf, Nano-Lok, Rollgliss, Salalift, Sayfl ink, ShockWave, STRATA, and Ultra-Lok are registered trademarks of 3M. Kevlar, Nomex and Technora are trademarks of their respective owners.



3M Fall Protection

3833 SALA Way
Red Wing, MN 55066 USA

Phone 800.328.6146

Email 3mfallprotection@mmm.com

Web 3M.com/FallProtection

Please recycle. Printed in USA.

© 3M 2022. All rights reserved.

